

**DTIC Copy**

**AFRL-PR-ED-TR-2004-0024**

**AFRL-PR-ED-TR-2004-0024**

---

# **Advanced Propulsion Study**

**Eric W. Davis**

**Warp Drive Metrics  
4849 San Rafael Ave.  
Las Vegas, NV 89120**

**September 2004**

**Special Report**

---

**APPROVED FOR PUBLIC RELEASE; DISTRIBUTION UNLIMITED.**

---



**AIR FORCE RESEARCH LABORATORY  
AIR FORCE MATERIEL COMMAND  
EDWARDS AIR FORCE BASE CA 93524-7048**

---

**REPORT DOCUMENTATION PAGE**Form Approved  
OMB No. 0704-0188

Public reporting burden for this collection of information is estimated to average 1 hour per response, including the time for reviewing instructions, searching existing data sources, gathering and maintaining the data needed, and completing and reviewing this collection of information. Send comments regarding this burden estimate or any other aspect of this collection of information, including suggestions for reducing this burden to Department of Defense, Washington Headquarters Services, Directorate for Information Operations and Reports (0704-0188), 1215 Jefferson Davis Highway, Suite 1204, Arlington, VA 22202-4302. Respondents should be aware that notwithstanding any other provision of law, no person shall be subject to any penalty for failing to comply with a collection of information if it does not display a currently valid OMB control number. **PLEASE DO NOT RETURN YOUR FORM TO THE ABOVE ADDRESS.**

<b>1. REPORT DATE (DD-MM-YYYY)</b> 04-02-2004		<b>2. REPORT TYPE</b> Special		<b>3. DATES COVERED (From - To)</b> 01 Mar 2003 – 28 Feb 2004	
<b>4. TITLE AND SUBTITLE</b>  <b>Advanced Propulsion Study</b>				<b>5a. CONTRACT NUMBER</b> F04611-99-C-0025	
				<b>5b. GRANT NUMBER</b>	
				<b>5c. PROGRAM ELEMENT NUMBER</b> 62500F	
<b>6. AUTHOR(S)</b>  Eric W. Davis				<b>5d. PROJECT NUMBER</b> 4847	
				<b>5e. TASK NUMBER</b> 0159	
				<b>5f. WORK UNIT NUMBER</b> 549907	
<b>7. PERFORMING ORGANIZATION NAME(S) AND ADDRESS(ES)</b>  Warp Drive Metrics 4849 San Rafael Ave. Las Vegas NV 89120				<b>8. PERFORMING ORGANIZATION REPORT NO.</b>	
<b>9. SPONSORING / MONITORING AGENCY NAME(S) AND ADDRESS(ES)</b>  Air Force Research Laboratory (AFMC) AFRL/PRSP 10 E. Saturn Blvd. Edwards AFB CA 93524-7680				<b>10. SPONSOR/MONITOR'S ACRONYM(S)</b>  XC	
				<b>11. SPONSOR/MONITOR'S REPORT NUMBER(S)</b> <b>AFRL-PR-ED-TR-2004-0024</b>	
<b>12. DISTRIBUTION / AVAILABILITY STATEMENT</b>  Approved for public release; distribution unlimited.					
<b>13. SUPPLEMENTARY NOTES</b> Prepared for ERC Purchase Order #RP030157					
<b>14. ABSTRACT</b> This study was tasked with the purpose of conducting a thorough literature and program search to carry out and document a technical assessment of the latest concepts in science and engineering that show promise of leading to a major advance in Earth-to-orbit (ETO) propulsion. The study also reviewed and evaluated a select number of credible far-term breakthrough propulsion physics concepts pertaining to R&D work done on or related to gravity/inertia modification, spacetime metric modification, and the extraction of energy from the space vacuum environment. The results of the study are presented and summarized in this report. A combined bibliography of advanced propulsion references was assembled and is presented. The report includes an overview of the recent history and present state-of-the-art of ETO launch vehicle and propulsion concepts. Also included is an outline and summary of the criteria and operative guidelines that the author used to examine, select and recommend advanced propulsion concepts. The author identified and selected five promising advanced propulsion concepts, and provides a detailed technical evaluation of their breakthrough potential for ETO propulsion.					
<b>15. SUBJECT TERMS</b> propulsion; earth-to-orbit; ETO; propulsion physics; gravity/inertia modification; spacetime metric; space vacuum; <u>advanced propulsion; launch vehicle</u>					
<b>16. SECURITY CLASSIFICATION OF:</b>			<b>17. LIMITATION OF ABSTRACT</b>	<b>18. NUMBER OF PAGES</b>	<b>19a. NAME OF RESPONSIBLE PERSON</b> Franklin B. Mead, Jr.
<b>a. REPORT</b>  Unclassified	<b>b. ABSTRACT</b>  Unclassified	<b>c. THIS PAGE</b>  Unclassified			A

## NOTICE

When U.S. Government drawings, specifications, or other data are used for any purpose other than a definitely related Government procurement operation, the fact that the Government may have formulated, furnished, or in any way supplied the said drawings, specifications, or other data, is not to be regarded by implication or otherwise, or in any way licensing the holder or any other person or corporation, or conveying any rights or permission to manufacture, use or sell any patented invention that may be related thereto.

## FOREWORD

This special technical report, entitled "Advanced Propulsion Study," presents the results of an in-house study performed under JON 48470159 by AFRL/PRSP, Edwards AFB CA. The Principal Investigator/Project Manager for the Air Force Research Laboratory was Dr. Frank Mead.

This report has been reviewed and is approved for release and distribution in accordance with the distribution statement on the cover and on the SF Form 298.

\_\_\_\_\_/S/\_\_\_\_\_  
FRANKLIN B. MEAD, JR.  
Project Manager

\_\_\_\_\_/S/\_\_\_\_\_  
RONALD CHANNELL  
Chief  
Propellants Branch

\_\_\_\_\_/S/\_\_\_\_\_  
PHILIP A. KESSEL  
Technical Advisor  
Space & Missile Division

\_\_\_\_\_/S/\_\_\_\_\_  
RANNEY G. ADAMS, III  
Public Affairs Director

This Page Intentionally Left Blank

## Table of Contents

Chapter 1 – Introduction .....	1
1.1 Present-Day Earth-to-Orbit Transportation – The Facts.....	1
1.2 The Birth and Death of Solutions .....	2
1.3 The Advanced Concepts Philosophy .....	6
Chapter 2 – The Classes of Advanced Propulsion Concepts .....	10
2.1 Relay Space Transportation.....	10
2.1.1 Aircraft-Rocket Relay .....	10
2.1.2 Projectile-Rocket Relay .....	10
2.1.3 Gunsling Relay .....	10
2.1.4 Coilgun-Laser Relay .....	11
2.1.5 Moon-Earth Momentum Exchange.....	11
2.2 Suborbital Space Transportation .....	11
2.3 Orbital Space Transportation.....	12
2.3.1 Orbiting Diamagnetic Particles.....	12
2.3.2 Orbital Slings .....	12
2.3.3 Orbital or Space Elevator.....	13
2.3.4 Orbital Ring .....	15
2.3.5 Orbital Coilgun .....	15
2.3.6 Rotating Orbital Pipe .....	15
2.3.7 Electrotube .....	15
2.3.8 Electrowheel .....	16
2.3.9 Orbital Loop.....	16
2.3.10 Skyhook .....	17
2.3.11 Sling on Tower.....	17
2.4 Terrestrial Space Transportation .....	18
2.4.1 Electrothermal Ramjet .....	18
2.4.2 Explosive Accelerators.....	19
2.4.3 One- and Two-Stage Light Gas Guns .....	19
2.4.4 Vortex Gun .....	20
2.4.5 Ice Gun.....	20
2.4.6 MagLev Train or MagLifter.....	21
2.4.7 Coilgun .....	22
2.4.8 Railgun.....	23
2.4.9 Laser and Microwave Rockets.....	23
2.4.10 Nuclear Rockets .....	23
2.4.11 Launch Loop .....	23
2.4.12 Slingatron.....	24
2.4.13 Geomagnetic Levitation.....	24
Chapter 3 – The Recommended Advanced Propulsion Concepts.....	25
3.1 The Final Selections.....	25
3.2 Explosive Accelerators: The Blast-Wave Accelerator.....	25
3.3 Beamed-Power Propulsion: Laser and Microwave Rockets.....	28
3.3.1 RF-Powered Lenticular Craft.....	28
3.3.2 Lightcraft.....	30
3.3.2.a Lightcraft Technology Demonstration Program .....	35
3.3.3 Summary of Technical Performance and Benefits.....	39
3.4 Nuclear Propulsion: Fission and Fusion Rockets. ....	40

3.4.1	QED/ARC IEF Reusable SSTO or Starfighter .....	40
3.4.2	Nuclear DC-X .....	48
Chapter 4 –	Conclusion.....	58
4.1	Future Advanced Propulsion Concepts.....	58
4.2	Quantum Vacuum Zero-Point Energy .....	58
4.2.1	Engineering the Vacuum .....	60
4.3	Engineering the Spacetime Metric.....	63
4.4	The Walker Aerospace Commission Policy Recommendations.....	69
Advanced Propulsion	References .....	70

## List of Figures

<b>Figure No.</b>	<b>Page No.</b>
Figure 1. Air Force Delta Clipper DC-X (from reference 201) .....	4
Figure 2. Air Force Delta Clipper DC-X (from reference 201) .....	5
Figure 3. The proposed Delta Clipper X-33 Entry (courtesy of P. March, LMCO) .....	6
Figure 4. Schematic of the Blast-Wave Accelerator (Bekey, 2003) .....	27
Figure 5. The Blast-Wave Accelerator can launch payloads into space or deliver weapons anywhere on the globe from CONUS (Bekey, 2003).....	27
Figure 6. The RF-Powered Lenticular Craft (Bekey, 2003) .....	29
Figure 7. The RF-Powered Lenticular Craft Ascending to Orbit (from <a href="http://www.Space.com">www.Space.com</a> ).....	30
Figure 8. Lightcraft During Launch (from <a href="http://www.Space.com">www.Space.com</a> ).....	32
Figure 9. Lightcraft During Launch (from <a href="http://www.Space.com">www.Space.com</a> ) .....	32
Figure 10. Cross-Sectional View of Laser Lightcraft Model 200-3/4 (Larson et al., 2002).....	33
Figure 11. Lightcraft Schematic (Froning et al., 2003).....	34
Figure 12. Lightcraft Flight-Test Vehicle used in Horizontal Guide-Wire Flight Tests (from <a href="http://www.Space.com">www.Space.com</a> ) .....	35
Figure 13. Lightcraft Undergoing Horizontal Guide-Wire Flight Test (From <a href="http://www.Space.Com">www.Space.Com</a> ) .....	36
Figure 14. Time-Lapse Photo Of A Lightcraft Undergoing An Outdoor Vertical Flight Test (From AFRL Press Release) .....	37
Figure 15. Lightcraft Undergoing Indoor Vertical Flight Test (From <a href="http://www.Space.Com">www.Space.Com</a> ) .....	38
Figure 16. Several Lightcraft Flight-Test Vehicles (From <a href="http://www.Space.com">www.Space.com</a> ) .....	38
Figure 17. The IEC Concept: Ion Acceleration By Electron-Injection-Driven Negative Potential Well Maintained In Polyhedral Magnetic Field (Bussard and Jameson, 1995).....	43
Figure 18. The IEC Fusion Direct Energy Converter Device: Fusion Reaction Ions Are Acceleration By Electron-Injection-Driven Negative Potential Well Maintained In Polyhedral Magnetic Field.....	44
Figure 19. IEC Fusion Direct Energy Converter Device .....	45
Figure 20. Experimental IEC Device Operating In The “Star Mode” at the University of Illinois Fusion Studies Laboratory (Miley et al., 1995) .....	46

Figure 21. Schematic Of A Complete QED/ARC IEC Rocket Engine System.....	46
Figure 22. QED/ARC IEC SSTO Reusable Winged Launch Vehicle Or Future Air Force Starfighter .....	48
Figure 23. Schematic of the LANTR Concept (from <a href="http://www.islandone.org/APC">www.islandone.org/APC</a> ) .....	51
Figure 24. Nuclear DC-X/LANTR SSTO Heavy Cargo Lifter (March, 2001) .....	55
Figure 25. Nuclear DC-X/LANTR SSTO Heavy Cargo Lifter (March, 2001) .....	55
Figure 26. Nuclear DC-X/LANTR SSTO Heavy Cargo Lifter (March, 2001) .....	56
Figure 27. Nuclear DC-X/LANTR SSTO Heavy Cargo Lifter (March, 2001) .....	56
Figure 28. Nuclear DC-X/LANTR SSTO Heavy Cargo Lifter (March, 2001) .....	57
Figure 29. The Alcubierre Warp Drive.....	64
Figure 30. Embedding Diagram For A Traversable Wormhole That Connects Two Distant Regions Of Our Universe .....	65
Figure 31. Realistic Illustration Of A Traversable Wormhole With A Flat Entry/Exit, Which Is Essentially A True “Stargate” Or Flat Doorway Or Portal Through Spacetime .....	66
Figure 32. Embedding Diagram For A Traversable Wormhole That Connects Two Distant Regions Of Our Universe.....	67
Figure 33. Generator Of A Dipole Repulsive Gravity (“Antigravity”) Field ( $G$ ) Through The Center Of The Torus.....	69



## Glossary

ABM – Anti-Ballistic Missile  
Al – Aluminum  
Am – Americium  
Am-241 – Americium-241 Isotope  
Am-242m – Americium-242m Isotope  
AFB – Air Force Base  
AFRL – Air Force Research Laboratory  
B – Boron  
 $B_{\text{field}}$  – Magnetic Field Strength  
BMDO – Ballistic Missile Defense Organization  
BPP – Breakthrough Propulsion Physics  
CIPA – California Institute for Physics and Astrophysics  
CONUS – Continental United States  
CO<sub>2</sub> – Carbon Dioxide  
Cu – Curium  
D – Deuterium  
DARPA – Defense Advanced Research Projects Agency  
DC – Direct Current  
DC-X – Delta Clipper-Experimental  
DC-XA – Delta Clipper-Experimental Advanced  
 $\Delta v$  – delta-v, propulsive change in velocity or velocity increment  
DoD – Department of Defense  
EELV – Evolved Expendable Launch Vehicle  
 $F$  – Thrust-to-Mass ratio  
FTL – Faster-Than-Light  
 $G$  – Gravitational Coupling Constant, or Universal Gravitation Constant, or Gravitational Field Strength  
GEO – Geostationary Earth Orbit  
GR – General Relativity  
GTOW – Gross Take-off Weight  
GW – GigaWatt  
H<sub>2</sub> – Hydrogen Gas  
H<sub>2</sub>O – Water  
He – Helium  
HELSTF – High Energy Laser Systems Test Facility  
HMX – Octogen Explosives  
IEC – Inertial Electrostatic Confinement  
IEF – Inertial Electrostatic Fusion  
 $I_{\text{sp}}$  – Specific Impulse  
J – Joule  
K – Kelvin Temperature  
kA – kiloAmpere  
kg – kilogram  
kN – kiloNewton  
kW – kiloWatt  
kWh – kiloWatt-hour  
 $\lambda$  – Wavelength  
LANL – Los Alamos National Laboratory  
LEO – Low Earth Orbit

## Glossary (Cont'd)

LH<sub>2</sub> – Liquid Hydrogen  
Li – Lithium  
LLNL – Lawrence Livermore National Laboratory  
LMCO – Lockheed-Martin Company  
LO<sub>x</sub> – Liquid Oxygen  
LX-10 – 95% HMX/5% Viton A binder (Explosive)  
MagLev – Magnetic Levitation  
MeV – Mega Electron Volt  
MV – MegaVolt  
MW – MegaWatt  
NASA – National Aeronautics and Space Administration  
NERVA – Nuclear Engine for Rocket Vehicle Applications  
NRX – Nuclear Reactor eXperiment  
NTR – Nuclear Thermal Rocket  
O<sub>2</sub> – Oxygen Gas  
p – proton  
PBO – Poly p-phenylene-2,6-bisoxazole  
PBX – Polymer Bonded Explosives  
PLVTS – Pulsed Laser Vulnerability Test System  
PPN – Parameterized Post-Newtonian  
Pu-239 – Plutonium-239 Isotope  
Pu-241 – Plutonium-241 Isotope  
PV-GR – Polarizable-Vacuum Representation of General Relativity  
QED – Quantum Electrodynamics  
QED/ARC – Quiet-Electric-Discharge, All-Regeneratively-Cooled  
QFT – Quantum Field Theory  
R&D – Research and Development  
RDX – Hexogen, Cyclonite, or Cyclotrimethylenetrinitramine (Explosive)  
RF – Radio Frequency  
RLV – Reusable Launch Vehicle  
RVT – Reusable Rocket Vehicle Test  
SDIO – Strategic Defense Initiative Organization  
SETI – Search for Extraterrestrial Intelligence  
SNRE – Small Nuclear Rocket Engine  
SREB – Sub-Relativistic Electron Beams  
SSRT – Single-Stage Rocket Technology  
SSTO – Single-Stage-To-Orbit  
TSTO – Two-Stage-To-Orbit  
U-235 – Uranium-235 Isotope  
UC-ZrC-C – Uranium Carbide-Zirconium Carbide-Carbide  
USAF – United States Air Force  
 $v_{ex}$  – Rocket Engine Exhaust Velocity  
 $v_{flight}$  – vehicle flight speed  
VTOL – Vertical Take-Off and Landing  
WSMR – White Sands Missile Range  
XE-Prime – eXperimental flight Engine Prototype  
ZPE – Zero-Point Energy(s)  
ZPF – Zero-Point Fluctuation(s)

## Acknowledgements

This study would not have been possible without the generous support of Dr. Frank Mead, Senior Scientist at the Advanced Concepts Office of the U.S. Air Force Research Laboratory-Propulsion Directorate at Edwards AFB, CA. Dr. Mead's collegial collaboration, ready assistance, and constant encouragement were invaluable to me. Dr. Mead's professionalism and excellent rapport with "out-of-the-box" thinkers excites and motivates serious exploration into advanced concepts that push the envelope of knowledge and discovery. The author owes a debt of gratitude and appreciation to both Dr. David Campbell, Program Manager, ERC, Inc. at AFRL, Edwards AFB, CA, and the ERC, Inc. staff, for supporting the project contract and for making all the paperwork fuss totally painless. Dr. Campbell and his staff provided timely assistance when the author needed it, which helped make this contract project run smoothly.

I would like to express my sincere thanks and deepest appreciation to my first longtime mentor and role model, the late Dr. Robert L. Forward. Bob Forward was the first to influence my interests in interstellar flight and advanced breakthrough propulsion physics concepts (i.e., "Future Magic") when I first met him at an AIAA Joint Propulsion Conference in Las Vegas, NV while I was in high school (ca. 1978). The direction I took in life from that point forward followed the trail of exploration and discovery that was blazed by Bob. He will not be forgotten. I would also like to thank both Dave Froning (Flight Unlimited) and Paul March (LMCO) for their valuable technical contributions to the Advanced Propulsion Study. Thanks also to Stan Friedman for providing key technical information on the historical ROVER/NERVA rocket experiments. Marc Millis (NASA-Glenn), Bernie Haisch (CIPA), Mike LaPointe (Ohio Aerospace Inst.), Frank Mead (AFRL), Bill Haloulakos, Bob Bussard, Alan Holt (NASA-JSC), Steve Howe, Claudio Maccone (Alenia Spazio), Greg Matloff, Stan Borowski (NASA-Glenn), Ivan Bekey, Dennis Cravens, Bill McGarity, Kirk Goodall (NASA-JPL), Bob Frisbee (NASA-JPL), Ron Koczor (NASA-MSFC), Marty Piltch (LANL), Kit Green, and John Alexander have all been influential and instrumental in my life and work. Additionally, I wish to give special thanks to my second mentor Dr. Hal Puthoff (Inst. for Advanced Studies-Austin) for providing me with valuable literature and excellent technical advice. Hal made many important technical contributions to the Advanced Propulsion Study. He is the most influential and instrumental of all my colleagues. Last, I would like to offer my debt of gratitude and thanks to my business manager (and spouse), Lindsay K. Davis, for all the hard work she does to make the business end of Warp Drive Metrics run smoothly.

Eric W. Davis, Ph.D., FBIS  
Warp Drive Metrics  
Las Vegas, NV

## Preface

The Advanced Propulsion Study is divided into two phases. Phase I is a review and documentation of the latest concepts in science and engineering that show promise of leading to a major advance in propulsion, especially Earth-to-Orbit (ETO) propulsion. This phase also included a study of all the concepts pertaining to R&D work done on or related to gravity/inertia modification, spacetime metric modification (i.e., traversable wormholes, space warps, polarizable vacuum representation of general relativity, etc.), and the extraction of energy from the space vacuum environment. At the completion of this phase the author recommended five promising advanced propulsion concepts for further evaluation. The author then presented an oral review and technical summary of the recommended advanced propulsion concepts at the AFRL Propulsion Directorate at Edwards AFB, CA on January 5, 2004. Phase II involved a detailed evaluation of the concepts identified and selected in Phase I, which were deemed by the author to have the greatest breakthrough potential for ETO propulsion. Phase II collated all of the results and presents them in this final report.

The report contains four chapters. Chapter 1 is an overview of the present state-of-the-art of ETO launch vehicle and propulsion concepts. The chapter also outlines and summarizes the criteria and operative guidelines that were used by the author to examine, select and recommend advanced propulsion concepts. Chapter 2 is a review and summary of a substantial number of advanced propulsion concepts the author evaluated for the study. Chapter 3 presents the author's five recommended advanced propulsion concepts, which includes a detailed technical evaluation of their breakthrough potential for ETO propulsion. Chapter 4 is a review and summary of a select number of far-term advanced propulsion concepts. The far-term propulsion concepts are comprised of breakthrough propulsion physics concepts that are very credible and rigorous. The report concludes with a combined list of references.

# Chapter 1 - Introduction

## 1.1 Present-Day Earth-to-Orbit Transportation – The Facts

Launch vehicle costs in \$/kg to orbit have been static for many, many years. Launch costs are typically 1/3 – 1/2 the total cost of fielding space systems. But yet the \$/kg cost of many types of spacecraft has been steadily decreasing over the years with the introduction of new technology and manufacturing techniques. Launch vehicles have not benefited at all from this trend. Launch vehicles tend to be:

- Fragile
- Complex
- 1,000 times less reliable than airliners
- 10,000 times more expensive than airliners per kg of payload

The “bottom line” for present-day launch vehicle technology is that the operational and economic constraints of their characteristics are the largest obstacles to more widespread and routine use of space. Evolved Expendable Launch Vehicle (EELV) systems, such as the Atlas-5 and Delta-4 vehicles, will not bring about any dramatic change in this regard. That is because the expected cost savings over current launch vehicles is  $\leq 25\%$ , which is due to (Bekey, 2003):

- Infrequent launches and very low average launch rates (for example, the worldwide launch rate has averaged 6 – 8 successful launches per month over the past 52 years)
- The costs for expended hardware (the entire vehicle!)
- The labor to assemble and validate a new vehicle for every launch
- Launch costs that reach \$15,000/kg
- System reliability = 0.99 (same as the Space Shuttle Transportation System)

We can compare this with the performance of present-day airline operations:

- Airlines launch tens of thousands of aircraft daily
- Aircraft are reusable thousands of times
- Aircraft expend nothing but propellants
- Aircraft operate at \$10/kg of payload
- Aircraft reliabilities = 0.999999

This simple comparison shows that present-day launch vehicle technology and its performance is too many orders of magnitude away from what we expect for a cost effective, high performance, highly reliable and reusable space transportation system.

## 1.2 The Birth and Death of Solutions

So what is the solution to this problem? During the late 1990's NASA developed the X-33 single-stage-to-orbit (SSTO) reusable launch vehicle (RLV) system as one solution (Cook, 1996; Baumgartner, 1997, 1998). X-33 was a half-scale experimental vehicle that was to demonstrate new technologies. The propulsion system was a high performance aerospike rocket engine based on conventional chemical propellants. The Lockheed-Martin Company (LMCO) and NASA entered into a cooperative agreement to develop the X-33 with Lockheed-Martin Skunk Works being the lead company. LMCO-Skunk Works designed the Venture Star SSTO as a full-scale commercial version of the X-33. X-33/Venture Star was designed to demonstrate a fully reusable SSTO launch vehicle having airline-type operation with a short turnaround time and operating costs  $\approx$  \$2,000/kg of payload. This program was prematurely cancelled in 2001 because of funding limits and some technical problems with hardware fabrication.

An earlier solution was the DC-X (see reference 201). Beginning in 1990 the Ballistic Missile Defense Organization's (BMDO) Single Stage Rocket Technology (SSRT) program was chartered to demonstrate the practicality, reliability, operability and cost efficiency of a fully reusable, rapid turnaround single stage rocket, with the ultimate goal of aircraft-like operations of RLVs. The program focused on using existing technologies and systems to demonstrate the feasibility of building both suborbital and orbital RLVs, which are able to fly into space, return to the launch site, and be serviced and ready for the next mission within three days. The DC-X propulsion system was a conventional chemical rocket. As part of the program, BMDO built an experimental suborbital launch vehicle, officially designated the SX-1 (Spaceplane Experimental), but known as the DC-X (Delta Clipper-Experimental).

The DC-X flight vehicle was constructed by McDonnell-Douglas-Huntington Beach (see Figures 1 – 3), and it was later modified into an advanced version called the DC-XA (Delta Clipper-Experimental Advanced). The DC-X/DC-XA was designed to take off vertically and return to land in the same attitude. It was a one-third scale model that was not designed to be an operational vehicle capable of achieving orbital flight. Its purpose was to test the feasibility of both suborbital and orbital RLVs. The DC-X completed five successful flights from 1993 to 1995 and then the program funding was terminated. In 1996 additional program funding was procured and the new DC-XA vehicle flew four successful flights. However, at the end of the fourth flight a single landing strut failed to extend, which caused the vehicle to tip over followed by the explosion of a LO<sub>x</sub> tank upon impact with the ground. The DC-XA vehicle was destroyed and the program ended due to lack of funding for a replacement vehicle. A notable achievement of the DC-XA was that it demonstrated a 26-hour turnaround between its second and third flights, which is a first for any rocket. The program was officially declared a success in spite of its abrupt termination. During the 1990's, the Japanese developed and flight-tested their version of the DC-X, called the Reusable Rocket Vehicle Test (RVT) program (Inatani, 2001). Several RVT flight-test vehicles were developed and flown. As recently as December 2002, the Japanese were conducting static-fire testing of the RVT rocket propulsion system (at the Rocket Test Center of Ishikawajima-Harima Heavy Industries Co., Ltd. in Aioi, Hyogo Prefecture) in an effort to increase engine reliability and durability.

The X-33/Venture Star and DC-X/DC-XA programs were recently replaced by unspecified 2<sup>nd</sup> generation partially/fully reusable government SSTO or TSTO (two-stage-to-orbit) vehicles having estimated launch costs of \$4,000 – 6,000/kg of payload. So far this has not received funding. However, there is a plethora of commercial advanced SSTO/TSTO RLV concepts that were identified and designed during the 1990's (see reference 249). Several companies constructed full- or sub-scale mockups or test vehicles that never flew. The majority of the companies have already gone out of business or have reduced their operations to a bare minimum due to lack of financing and/or poor economic conditions, and only two or three viable companies survive today.

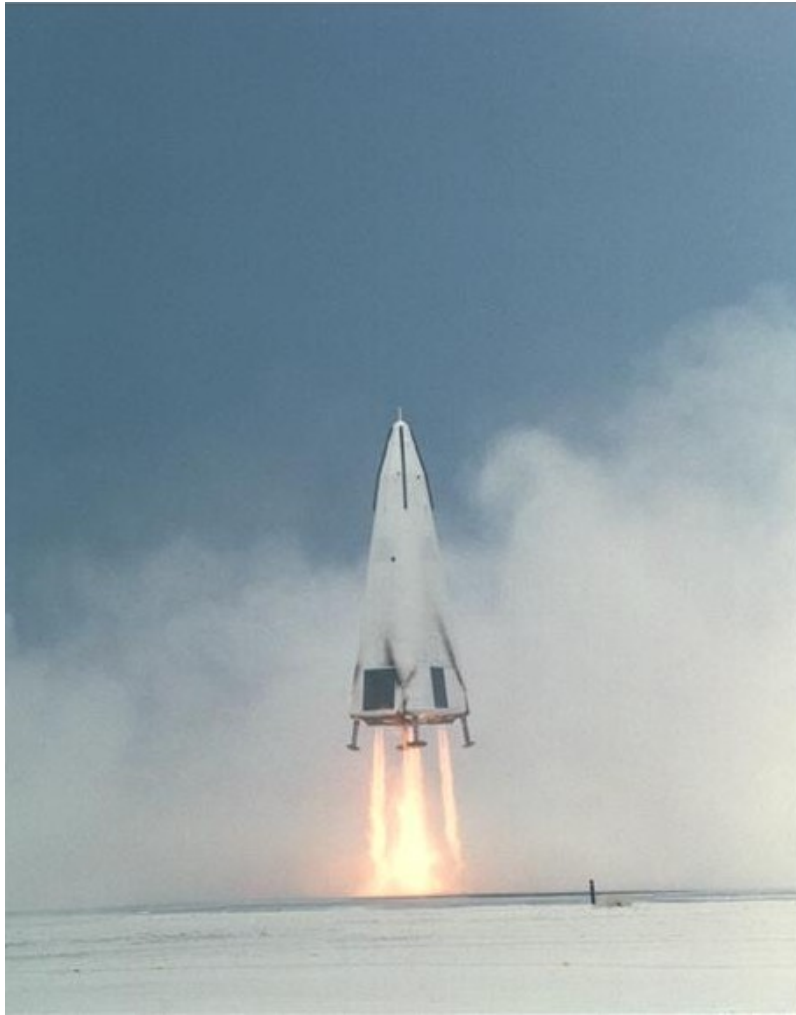
One of the survivors is Burt Rutan's Scaled Composites LLC, which rolled out a novel fully operational suborbital RLV system in April 2003 (see reference 239). This is the first privately owned and operated manned space program to have fielded operational flight hardware. The system is comprised of the SpaceShipOne rocket that is air-launched at 15.24 km altitude from the White Knight high-altitude aircraft. Once released, SpaceShipOne will fire its hybrid rocket engine and climb to over 100 km while carrying a crew of three into space on a suborbital flight. This system is the first operational hardware designed to demonstrate a fully reusable launch vehicle having airline-type operation with a short turnaround time and very low operating costs ( $\approx$  \$300 – 400/kg). It is also the first new man-rated rocket system to have been developed in the United States in 30 years. The entire program was developed for \$20-30 million, which was provided by Microsoft Corp. co-founder Paul Allen. The first test flight into suborbital space is expected to take place before this report goes to press. However, SpaceShipOne exceeded the speed of sound during an atmospheric test flight on Dec. 17, 2003. This novel RLV system is designed for near-future suborbital space tourism and some military applications.

All the advanced RLV concepts designed or developed to date have relied on low performance conventional or hybrid-conventional propulsion technology. RLV designers have avoided applying truly advanced unconventional propulsion technology, which would dramatically increase performance and lower operating costs. Suborbital RLV operating costs will always be inexpensive because there is no need for the system to achieve orbital velocity at any point along the spacecraft trajectory. However, missions requiring orbital insertion and/or a change in orbital plane and altitude require much higher  $\Delta v$ , and therefore, will require much higher system performance in order to achieve lower operating costs. The key to engineering a higher performance, low operating cost launch system is to exploit unconventional advanced propulsion technologies.



**Figure 1. Air Force Delta Clipper DC-X (From Reference 201)**





**Figure 2. Air Force Delta Clipper DC-X (From Reference 201)**



**Figure 3. The Proposed Delta Clipper X-33 Entry (Courtesy Of P. March, LMCO)**

### **1.3 The Advanced Concepts Philosophy**

The guidelines or criteria used in this study to examine, select and recommend advanced propulsion technologies are based on the “Advanced Concepts Philosophy” that was developed and advocated for decades by Ivan Bekey (2003) and Robert L. Forward (1988). The guidelines I found most useful for this study are (Bekey, 2003):

- ❑ Think out of the box and avoid seductively easy linear extrapolations
- ❑ Avoid 10% improvements
- ❑ Emphasis is NOT on incremental improvement but rather on *disruptive innovation*, which is defined as the generation of capability so great that *revolutionary change occurs*
- ❑ Concentrate on technologies and applications possessing a potential for orders-of-magnitude change
- ❑ Aim the advanced concepts horizon well beyond the “program improvement” level
- ❑ Pay NO attention to current political or policy “correctness” nor to likely required budgets if the advanced technology capability proves unusually useful

- ❑ Collect and innovate concepts that might be useful, but not necessarily those that should be built nor necessarily the most likely to be funded or accepted
- ❑ Identify possibilities, and do not get wedded to the concept
- ❑ Innovate, invent and collect application ideas and technology wherever found
- ❑ Include useful nearer-term ideas and technologies if unconventional, overlooked, or discarded for invalid reasons

We require that the advanced propulsion concepts we select possess the following important characteristics (Bekey, 2003):

- ❑ New capability – paradigm shift
- ❑ Order-of-magnitude improvement
- ❑ Unconventional – out-of-the-box
- ❑ Perhaps high risk
- ❑ Perhaps long term
- ❑ Activity of any scale – local, national, or international

Other selection criteria used for this study are the “Operative Guidelines for Advanced Concepts” (Bekey, 2003):

- ❑ Concentrate on revolutionary missions, if feasible
- ❑ Try to do from space whatever can be done from air or ground
- ❑ Perform as many global functions as possible from CONUS
- ❑ Aim to reduce or remove crews from harm’s way
- ❑ Capitalize on commercial capabilities that are likely to materialize
- ❑ Revisit previously known but overlooked techniques that are still promising
- ❑ Search for concepts that support unconventional, but high-leverage, missions (such as force projection and multiplication)
- ❑ Stay well within the known and accepted laws of physics, but it’s OK to explore new physics
- ❑ Pay no attention to policy, political, or budgetary limitations
- ❑ Be politically incorrect when necessary

We also demand that selected advanced propulsion concepts allow system operation at:

- greater margins
- high reusabilities
- low maintenance
- reduced launch costs

Bekey (2003) points out that launch operating costs would be dramatically reduced if a space mass market were to exist. He estimates that a space mass market consisting of thousands of annual launches would substantially decrease operating costs to  $\approx$  \$20/kg of payload using only conventional propulsion technology. In this case, rocket propulsion performance would be traded off in favor of much higher launch rates. The space mass market is defined to be (Bekey, 2003):

- military and intelligence space operations [via National Security Space Programs, see for example the Rumsfeld Space Commission Report (Rumsfeld et al., 2001)]
- space tourism and industry (providing the public total access to space)
- space-based electrical (beamed) power utilities
- solar system and interstellar/extrasolar planets exploration (manned and/or robotic); astronomy/astrophysics, SETI, astrobiology, astroarchaeology, etc.
- space infrastructure and economic development, solar system resource exploitation

There are two primary categories of “promising concepts” that we look at when reviewing and selecting advanced propulsion concepts (Bekey, 2003). First there is the overlooked, promising near-term concepts. These are the concepts that do not require development of new technology or technology risk reduction. They are well known, but overlooked, near-term concepts that are not in development for reasons involving politics, agenda, legacy, or simple resistance to different ways of doing things. Near-term concepts possess substantial unrealized benefits, and do not require technology development. Second, there are the mid- and far-term concepts. These involve a degree of technology development or risk reduction. Mid/far-term concepts have such far-reaching capabilities that they represent a new and vital way of realizing the benefits of space.

Bekey (1983, 2003) cites one interesting case study of a near-term, overlooked advanced propulsion concept involving the use of space tethers (fail-safe multi-line or ribbon-type). A scheme using any launch vehicle (with few modifications) plus tethers would simultaneously increase its payload capability and decrease the cost of placing a given payload into orbit. This capability will be added at a lower marginal cost/kg than the cost of the basic launch vehicle. This study showed that the concept works for any expendable, reusable, single or multiple stage launch vehicles. In particular, a system design was carried out for a Delta-class launched payload ( $\approx$  25,000 kg). The payload is tethered to the launch vehicle (or its last stage) and transfers energy and angular momentum at  $\approx$  100% efficiency from the launch vehicle (or last stage) mass to the payload mass. This mechanism trades off the excess or deficit orbital energy to achieve orbital transfer of the payload. The Delta III can place 6,000 kg into a 1,000 km polar orbit. The use of a tether system results in a 280 kg gross gain (or 180 kg net gain since the tether system mass is 100 kg) in payload mass to the same orbit. The cost of the tether equipment is  $\approx$  \$200,000. Therefore, the cost of the extra payload capability gained is  $\approx$  \$1,300/kg, which is ten times

lower than the cost of the basic Delta III launch vehicle (Forward, 2001; Bekey, 2003). Payload orbital altitudes, inclinations, or both can be changed using a tether system (see Forward, 1992a; Cosmo and Lorenzini, 1997; Bangham et al., 1998; Hoyt, 2000a, b).

In Chapter 2 we briefly summarize those advanced concepts that were reviewed, but not selected as finalists for this study. We present our selected advanced propulsion concepts in Chapter 3.

## Chapter 2 – The Classes of Advanced Propulsion Concepts

### 2.1 Relay Space Transportation

This class of advanced propulsion concepts includes:

- Aircraft-Rocket Relay
- Projectile-Rocket Relay
- Gunsling Relay
- Coilgun-Laser Relay
- Moon-Earth Momentum Exchange

#### 2.1.1 Aircraft-Rocket Relay

This concept involves conventional TSTO propulsion. Examples of this are Orbital's Pegasus, Scaled Composites' White Knight/SpaceShipOne (suborbital), Bristol Spaceplanes' Spacecab and Spacebus, Kelly Space & Technology's Eclipse, Pioneer Rocketplane's Black Horse and Pathfinder, Kistler's K-Series, Buzz Aldrin's Star Booster, Space Access's TSTO Spaceplane, Zegrahm Space Voyages' Space Cruiser System, Cosmopolis XXI Suborbital Corporation's Cosmopolis XXI TSTO (suborbital), the balloon-launched daVinci, the POGO, etc. (See reference 249.) Although this category has numerous advanced vehicle concepts, we will not consider them further because they are all based on low performance conventional propulsion technology.

#### 2.1.2 Projectile-Rocket Relay

This concept combines the acceleration of a rocket with a low cost gun system. It is well suited for large payloads that must be transported in one piece. The scheme relies on a conventional chemical rocket to accelerate a payload to  $\approx 2$  km/s, and after launch, the gun launches projectiles filled with solid (or liquid) rocket propellant. The rocket then docks with the projectiles above the atmosphere, and uses the fuel contained within them to accelerate the cargo to orbital injection velocity. The minimum launch system mass is 10 tons for a 1-ton payload. An electrowheel or electrotube could be substituted for the gun, as it does not subject the fuel-projectiles to extreme acceleration. No bibliography exists for this concept, and thus there is no design data or case studies with which to make a proper evaluation. There are also significant questions about the overall safety and reliability of such a system. This concept will not be considered further.

#### 2.1.3 Gunsling Relay

A gunsling relay rotates like a sling to propel a payload (projectile) to orbit. It is comprised of a bundle of strong plastic fibers bound with resin in the center of rotation and on the surface adjacent to the projectiles. The projectile slides inside the system and is not attached to the tip of the sling. The projectile gets its kinetic energy from the centrifugal force of the sling and the Coriolis force, which doubles the kinetic energy. A projectile is fired from a stationary gun at 3.5 km/s into the first gunsling. The projectile then enters the second gunsling. Each gunsling has the same angular velocity and size, and

contributes the same kinetic energy to the projectile. Payloads will be exposed to extreme acceleration in this scheme.

Gunslings must be made of a material possessing high specific strength (Zylon PBO fiber or single-wall carbon nanotubes, for example). Six gunslings are required to accelerate projectiles to orbital velocity, and there must be an even number of gunslings rotating in opposite directions in order to eliminate gyro effects and reduce the angular velocity of the projectiles. Synchronizing the gunslings is accomplished by geared shafts, gunslings timing and shape. The gunslings spin inside a vacuum chamber supported by a stratospheric blimp, which floats at an altitude of 37 km, where atmospheric pressure is 1% of sea level pressure. The low pressure reduces stress in the vacuum chamber and atmospheric drag on the projectiles. The gunslings use miniature turbojets for power and to resist the force of jet streams.

The projectiles are released at a 10 degree angle to the horizon into an elliptical orbit with an apogee of 10,000 km. When the projectile reaches apogee, an internally mounted solid propellant rocket motor is ignited to circularize the orbit. The projectiles are fitted with axle-like protrusions, which match rifled grooves inside the gunslings, in order to reduce angular velocity and centrifugal stress of spinning about their center of mass. The projectiles must be in the shape of a disk to ensure that they rotate about an axis of symmetry after leaving the atmosphere.

A 100 kg gunslings can launch a 1 kg projectile at 4 km/s. The gunslings simultaneously releases two projectiles in opposite directions in order to reduce shock stress and recoil. The estimated minimum system mass is 100 tons to launch a 1 ton payload.

No bibliography exists for this concept, and thus there is no extensive design data or case studies with which to make a proper evaluation. This is a novel concept that involves highly complex mechanisms, fine-tuned energetics and mechanical timing, a requirement for highly specialized materials, along with a requirement for difficult-to-achieve infrastructure at high altitudes and in space. This concept will not be considered further.

#### **2.1.4 Coilgun-Laser Relay**

No design, conceptual information or bibliography exists for this concept. Therefore, it will not be considered further.

#### **2.1.5 Moon-Earth Momentum Exchange**

The Moon-Earth momentum exchange scheme involves transporting large quantities of raw materials from the Earth and the Moon to LEO. This concept utilizes a number of different advanced propulsion schemes to transport raw materials, and it is strictly mission-limited to that goal. Therefore, this is not a true advanced propulsion concept, and it will not be considered further.

### **2.2 Suborbital Space Transportation**

This class of advanced concepts includes:

- Chemical Rocket Launcher
- Turboengines
- Nuclear Rocket Launcher
- Ramjets and its kin

This class pertains to suborbital space propulsion, which severely limits the type and scope of missions envisioned by the USAF, other DoD components, NASA and most commercial ventures. Therefore, we will not consider this class further. However, most of the advanced ETO propulsion concepts described in Section 2.4 can adequately support the full scope of suborbital missions.

## **2.3 Orbital Space Transportation**

This class of advanced concepts includes:

- Orbiting Diamagnetic Particles
- Orbital Slings
- Orbital or Space Elevator
- Orbital Ring
- Orbital Coilgun
- Rotating Orbital Pipe
- Electrotube
- Electrowheel
- Orbital Loop
- Skyhook
- Sling-on-Tower

### **2.3.1 Orbiting Diamagnetic Particles**

This scheme envisions dumping 100 million tons of shrapnel-size diamagnetic particles into an eccentric Earth orbit, thus forming a ring around the Earth similar to Saturn. An electromagnet rides upon the orbiting particle stream and transports payloads to space. Magnetic shepherding of the particle stream is performed by other electromagnets riding on the stream. This concept requires a minimum of  $10^8$  tons of system mass to handle a 1-ton payload. This concept is largely unfeasible because it introduces a major orbital debris hazard, and particle and micrometeoroid collisions would destroy the electromagnets and disperse the orbiting stream into space. We will not consider this concept further.

### **2.3.2 Orbital Slings**

Forward (1988, 1990, 1992b) distinguishes two types of orbital slings: the “rotovator” and the “bolo.” The rotovator picks up payloads from the Earth’s surface (or from high up in the atmosphere) and accelerates them to orbital velocity (Artsutanov, 1969). The bolo can change payload velocity and direction, but not accelerate it from a standstill to orbital velocity (Chapman, 1981; Lorenzini et al., 2000). We will not consider bolos further as their application is more relevant to orbit changing missions.

The rotovator sling orbits the Earth and spins about its center of mass. The rotovator’s motion resembles the motion of a wheel spoke riding on the ground. A hook is placed on both ends of the



rotovator and picks up payloads from the Earth's surface or from high up in the atmosphere. This concept suffers from the problem that the end of the sling heats up when it plunges back into the atmosphere, and gravitational tidal forces and gradients severely perturbs the sling. The sling system must be constructed from ultrahigh specific strength materials in order to handle the extreme physical loads along with providing lasting durability and reliability.

Single-wall carbon nanotubes (a.k.a. "Buckytubes"), consisting solely of carbon atoms connected together by their atomic bonds and requiring no matrix materials to hold their alignments, possess the necessary properties for this concept. Buckytubes possess a strength-to-weight ratio of 600 times greater than that of high strength steel or aluminum alloys. However, the present state-of-the-art in Buckytube R&D is confined to introducing unoriented Buckytubes bound by epoxy or other matrix materials within 5 – 10 years, thus leading to only a small factor increase in the strength-to-weight ratio compared to traditional composite materials. Manufacturing and assembling pure Buckytube structures is very much into the far-term (beyond 20 years in the future). Using advanced plastic fibers for the sling material is out of the question because they are vulnerable to space radiation and thermal fatigue. To launch a 1-ton payload into orbit will require a rotovator system mass that is greater than the mass of the Earth, if a steel sling is used. We will not consider this concept further.

### **2.3.3 Orbital or Space Elevator**

This concept is a superior variant of the "skyhook" (see Section 2.3.10). A space elevator is essentially a massive system that shuttles payloads in an elevator up a tower extending from the Earth's surface to orbit, or from LEO to higher orbits (Isaacs et al., 1966; Pearson, 1975; Clarke, 1981; Forward and Moravec, 1981; Bekey, 1983; Edwards, 2000a, b; Mottinger and Marshall, 2001). A geostationary tower is a version that extends from the Earth's surface to GEO (Landis and Cafarelli, 1995). The elevators are attached to either a tower built from the ground up to space or a cable that hangs down from space to the Earth's surface.

An elaborate version of this concept is the Space Fountain or Launch Loop. In this scheme the upper ends of a skyhook are supported at less-than GEO altitudes using a stream (fountain) of metal projectiles (pellets made of empty aluminum balls, elliptical metal rings made of beryllium or aluminum) that would be shot from a space platform hovering motionless at 2,000 km altitude to another platform partway around the Earth. The projectiles are accelerated by (superconducting) electromagnets acting like a linear motor (a.k.a. a mass driver), whereby a sheath in the lower part of the elevator protects the projectiles from the atmosphere. The projectiles would be deflected by the second platform to the next platform until the polygonal projectile stream made its way around the Earth back to the original station. The deflection of the projectiles at each station would be sufficient to support that station in the Earth's gravity field at that altitude. The Launch Loop differs from the Space Fountain in a very minor way. The Space Fountain/skyhook elevator concept is superior to the ground-to-space elevator concept.

The Hyde (1985) Space Fountain design has a stream of projectiles being shot up through the bore of a hollow tower. As the projectiles travel along the tower, they are slowed down by electromagnetic drag devices that extract energy from the upgoing stream turning it into electricity. As the projectiles are braked, they exert a lifting force on the tower, which supports the weight of the tower. A large superconducting bending magnet turns the projectiles around when they reach the top of the tower. The projectiles also exert an upward force on the station at the top of the tower during the turnaround process, thus keeping the station levitated above the payload's launch point.

Superconducting electromagnetic drivers accelerate the projectiles as they travel back down the tower. The drivers use the electrical energy extracted from the upgoing stream of projectiles. The push exerted by the tower drivers acts to support the weight of the tower. The projectiles reach the ground at the bottom of the tower with nearly the same velocity they had when they were launched. Additional bending magnets are used to turn the stream through one 90-degree turn, one large circular turn, and then another 90-degree turn at the bottom of the tower. Another electromagnetic driver is used there to boost the stream back up to the original launch velocity during this process. The various parts of the external

structure are stressed by the transfer of momentum from projectile stream. The stressed structure and projectile stream together form a rigid, stable structure that is not limited in height by the strength of materials.

The basic elevator concept is extremely massive, unless it is made of ultrahigh specific strength materials like Buckytubes. The minimum elevator mass to shuttle a 1-ton payload into orbit is  $> 10^6$  tons (in the Space Fountain scheme the top station mass is 2 million tons). This mass estimate also applies to the Space Fountain/Launch Loop scheme. The Coriolis force of moving payloads destabilizes the elevator. A propulsion system (electrodynamic tether plus ion rocket or solar sail) would need to be placed at the top end of the elevator to stabilize it. However, the sideways Coriolis force does not affect the Space Fountain, because at each motor station, the direction of the upgoing stream is deflected slightly to one side to keep it going straight upward from the launch point. The tower structure responds by experiencing a force in the other direction. The Coriolis force is also canceled by an opposing force from the driver motors on the same platform as they deflect the down-going stream a small amount in the opposite direction to keep it going straight.

The Space Fountain requires over a million projectiles, with a total mass of 9,000 tons, circulating in the system. Each projectile would need to be the size of a hula-hoop with a mass of 9 kg. (The projectiles required for the Launch Loop version are bars of iron 2.5 mm thick  $\times$  5 cm wide  $\times$  1 m long, whereby the ends of the bars are interleaved like tongue and groove boards into a continuous ribbon of iron moving at 12 km/s.) The electromagnetic mass driver on the Earth's surface would need to be built in tunnels underground, and it would be 2 km in radius. Each of the bending magnets would need to provide  $\geq 15$  Tesla of field strength. The projectiles are launched from the ground at 24 km/sec and would have a 3-hour roundtrip time. The total circulating power in the Space Fountain is  $\approx 7$  TW, but total input drive power is  $\approx 14$  GW. And last, there are 8,000 deflector stations at 5 tons each, spaced at  $\approx 4$  km intervals along the Space Fountain. If the power systems were to fail, then the Space Fountain would literally fall apart, such that the upper stations would go into orbit and the intermediate stations would fall to Earth and burn up in the atmosphere on re-entry. The projectiles used in the system would then become a major orbital debris hazard, and this remains true if some of them were to stray from the streams during routine operation.

This structure is immense in mass, length-scale and complexity; and related safety and reliability issues have yet to be adequately addressed by designers. The Space Fountain could be built now without the need for Buckytubes, but its cost and infrastructure requirements are too massive an undertaking for the near future. Nothing has been done to address the interaction between the space-based elements of the Space Fountain infrastructure and radiation from the Van Allen belts between 5,000 and 13,000 km altitude. The single high point of this concept is that it has the potential of transporting six million tons of payloads per year up to 30,000 km for the cost of the electrical power to run it.

Edwards (2003) and Edwards and Westling (2003) claim that a traditional space elevator could be constructed using existing technology with the exception of the ultrahigh specific strength material required. Their study found that the material, based on unoriented carbon nanotube composites, is currently under development and is expected to be available in two years. They estimate that a space elevator could become operational in 15 years for \$10 billion. The manufacturing state-of-the-art for unoriented carbon nanotube composites is still immature, and large-scale (meters to kilometers long with 10 micron diameter) construction quality fibers (and/or tapes) are not yet available. There are challenges to making such composites and they are: uniform dispersion and alignment of the nanotubes in a composite matrix, formation of a smooth and defect-free fiber, efficient stress transfer from the matrix to the nanotube, and attaining high nanotube loadings. Ultrahigh specific strength performance of present carbon nanotube composites is still two to three orders of magnitude below what is required to construct a practical space elevator.

A space elevator made from pure Buckytubes (with oriented nanotubes) or unoriented nanotube composites will be strongly susceptible to severe or adverse atmospheric weather conditions, geophysical and atmospheric electrical disturbances, and space radiation. Edwards (2003) has addressed a small

subset of these in his study. The minimum mass of a steel geostationary tower is estimated to be greater than the mass of the Earth, and buckling makes it more massive than a skyhook. The space elevator concept has great merit, but it suffers from huge technical challenges, extreme system complexity, and high cost. Therefore, we will not consider it further in this study.

#### **2.3.4 Orbital Ring**

An orbital ring is comprised of two or more space elevators connected together in orbit by an orbital MagLev train system (Birch, 1982, 1983a, b; Brakke, 1982). The MagLev trains ride on a massive segmented metal cable that orbits the Earth. Payloads are transported up to orbit from the Earth's surface via the elevators, and then are transported around Earth orbit in the trains. The trains also serve the purpose of stabilizing the cable and replenishing its orbital energy. The estimated minimum mass for this system to transport a 1-ton payload up to and around orbit is  $\geq 10^8$  tons. This concept has all the massiveness, cost, complexity and technical challenges as the space elevator. We will not consider this concept further.

#### **2.3.5 Orbital Coilgun**

This concept relies on a conventional (expendable or reusable) rocket or gun to launch a payload to orbit and into an orbital coilgun (Arnold and Kingsbury, 1979a, b). The coilgun converts some of the kinetic energy of the payload into the kinetic energy of flywheel generators. The orbital energy of the coilgun is replenished by electrodynamic tethers and by launching empty rockets back to Earth. The structure of the coilgun must be segmented in order to prevent buckling of the structure. The minimum mass for this system to transport a 1-ton payload is  $\geq 10^6$  tons. This concept is massive and costly, but it is an efficient way to transfer payloads to higher orbits. It has the potential to bring overall launch costs down by one or two orders of magnitude. However, the tether system detailed in Section 1.3 does the same job at a far lower cost and mass than the orbital coilgun. This concept will not be considered further for this study.

#### **2.3.6 Rotating Orbital Pipe**

This concept involves launching payloads into space on conventional (expendable or reusable) rockets. The rocket transports the payload to a rotating orbital (slender) pipe, whereby half of the orbital energy of the pipe is transferred to the payload and the other half is wasted as heat (Welch and Jack, 1995). The payload rides on the outside of the pipe and a magnet attached to the payload generates eddy currents in the pipe, which accelerates the payload. The pipe acts like an electrodynamic tether because of the electric current flowing through it, so it is able to replenish its orbital energy. Buckling of the pipe is a primary technical problem that makes this concept impractical. Again, a system using either a non-electrodynamic or electrodynamic tether is technically more effective and cheaper to use. We will not consider this concept further.

#### **2.3.7 Electrotube**

This is an elastic version of the capture tube concept. A capture tube is a rigid tubular device, which captures a payload and accelerates it by magnetic drag or friction. The electrotube concept is comprised of a funnel made of aluminum alloy, elastic tube made of aluminum alloy, electronics and solar cells. A conventional (expendable or reusable) rocket or gun launches a payload into space and into the funnel, which guides the payload into the elastic tube. Magnets attached to both ends of the payload generate a repulsive force that prevents physical contact between the payload and the tube. However, the magnets are primarily used to induce eddy currents in the funnel and tube, thus generating a magnetic drag that

accelerates the payload. A gyro must be mounted in the payload to help stabilize it during flight through the funnel. And the payload must be coated with a silicone rubber to protect it from vibration and heat.

The elastic tube has a corrugated shape so that it stretches easily, and slow rotational centrifugal force keeps it straight. The last one percent of the elastic tube length must be structurally rigid in order to prevent buckling of the tube ahead of the payload. This is a flexible structure with an effective speed of sound that is smaller than the relative velocity of the payload. The estimated system mass to transport a 1-ton payload to higher orbits is 100 tons.

There are also electrotubes made from composite aluminum foil reinforced with carbon fibers and internal hoops, rigid aluminum hoops connected together by cables, and silicone rubber with mercury or gallium filled cavities. In the first two designs, the payload rides on the outside of the tube or hoops. Obsolete satellites are attached to both ends of the structure, and the structure rotates about its center of mass and held together by the tension of centrifugal force. The last design functions much like the aluminum funnel tube in the previous paragraph. In all cases, the payload must be very slender to prevent collision between the payload and the funnel and tube structures.

This concept has no bibliography available with which to make a proper analysis and evaluation. Therefore, it will not be considered further.

### **2.3.8 Electrowheel**

The electrowheel is another elastic capture tube concept that combines the features of the electrotube and electrodynamic tether. A conventional (expendable or reusable) rocket or gun launches a payload from Earth and up to the electrowheel. The payload then rides on the electrowheel and is accelerated to orbital velocity by magnetic drag or friction.

The electrowheel is stationed in an equatorial orbit and rotates about an axis parallel to the Earth's rotation axis. This generates a centrifugal force that maintains the round shape of the electrowheel, and increases the relative velocity between the system and the payload. The bottom edge of the electrowheel has a perigee of 200 km on the sunward side of Earth.

The electrowheel is made of aluminum foil held against centrifugal force by piano wires. It is a flexible structure with an effective speed of sound that is smaller than the relative velocity of the payload, and the structure must not buckle ahead of the payload. The payload has three sets of double magnets attached, which induce eddy currents in the foil, thus generating a magnetic drag that accelerates the payload. Half of the orbital energy of the system is transferred to the payload, and the remainder is wasted as heat. The minimum mass for this system to transport a 1-ton payload is  $\approx 1,000$  tons. The maximum diameter of the system is limited by the thickness of the ionosphere to  $\approx 1,000$  km.

This concept has no bibliography available with which to make a proper analysis and evaluation. Therefore, it will not be considered further.

### **2.3.9 Orbital Loop**

This concept requires an endless tether to be launched into an eccentric Earth orbit. The tether is interspersed with winches and a telescopic capture tube. The loop is composed of 10,000 segments with each segment consisting of two parallel, two-centimeter wide tethers attached to the winches on each end. The distance between adjacent winches oscillates between 3.2 and 7 km. The capture tube that accelerates the payloads is 200 km long.

A conventional (expendable or reusable) rocket transports the payload to the capture tube. The altitude of the capture tube is to be reduced to the maximum range of the gun or rocket before the payload is launched. The loop undulates and changes its tension in order to move the capture tube into the path of the unguided payload. Vertical undulation compromises stability of the loop, so the loop must undulate horizontally. Inside the capture tube the payload is accelerated by friction to orbital velocity. When the payload reaches orbital velocity, it drops off the loop and is carried to its final orbit by any choice of low-thrust propulsions systems. The payload must be enclosed in a ball-shaped container coated by thick

silicone rubber to protect it from vibration and heat. Magnets are placed inside the payload to generate eddy currents in the capture tube and induce magnetic drag.

Half of the orbital energy of the loop is transferred to the payload, and the other half is wasted as heat. The loop's velocity and tension undergo periodic changes along its eccentric orbit. These changes make it possible to restore the loop's orbital energy without the use of propellants or tethers. The loop's orbital energy is replenished by having the winches exert a periodic force on the loop, which is synchronized with the loop's orbital motion. The loop can be stabilized against the Earth's gravitational perturbations by the winches or by wings that interact with the ionosphere. The loop must be highly eccentric to generate the maximum tensile stabilization power and carry the maximum payload mass. The overall dynamic behavior of an orbital loop is extremely complex, and requires the use of computer simulation for analysis.

The average tether area exposed to meteoroids is  $102 \text{ m}^2$ , and there is a 50% probability that meteoroids or orbital debris will break a given tether within 25 years (Bacarat and Butner, 1986). If a tether is broken, then the loop must be relaxed in order to avoid breaking the other tether of the same segment. If both tethers of the same segment are broken, then the loop ruptures and will be unable to carry payloads until it is repaired.

This is another interesting, but overly complex concept, but there is no significant bibliography available with which to make a proper analysis and evaluation. Therefore, this concept will not be considered further.

### **2.3.10 Skyhook**

The skyhook (a.k.a. Jacob's Ladder or beanstalk) concept comprises a vertical fishnet tether that extends from the Earth's surface to GEO or beyond (Isaacs et al., 1966; Lvov, 1967; Pearson, 1975; Moravec, 1977; Clarke, 1981; Forward and Moravec, 1981; Ebisch, 1982; Bekey, 1983; Edwards, 2000b). The tether is curved due to the Coriolis force generated by moving payloads. Payloads are shuttled up and down via an elevator system. Another version of this is the skyhook-on-tower, which is a vertical fishnet tether that extends from the top of a very tall tower to GEO or beyond.

The minimum mass of a steel skyhook or skyhook-on-tower is greater than the mass of the Earth. Therefore, Buckytubes will be required to make this concept feasible. The minimum mass of a Buckytube skyhook that transports a 1-ton payload is  $10^4$  tons. The structural elements required to prevent buckling of the skyhook-on-tower makes this version heavier than the basic skyhook. A skyhook or skyhook-on-tower made from pure Buckytubes (with oriented nanotubes) or unoriented nanotube composites will be strongly susceptible to severe or adverse atmospheric weather conditions, geophysical and atmospheric electrical disturbances, and space radiation. This concept is technically inferior to the space elevator. Therefore, we will not consider it further in this study.

### **2.3.11 Sling on Tower**

This concept requires a 100 km high tower to be situated on one of the Earth's poles in order to mitigate against precession of the sling. A sling is attached to the top of the tower and rotates about a vertical axis. The minimum mass of a steel sling to transport a 1-ton payload is greater than the mass of the Earth. The mass could be dramatically reduced by using the Buckytubes. There is no bibliography available with which to make a proper analysis and evaluation. Therefore, this concept will not be considered further.

## 2.4 Terrestrial Space Transportation

This class of advanced concepts includes:

- Electrothermal Ramjet or Rocket
- Explosive Accelerators
- One- and Two-Stage Light Gas Guns
- Vortex Gun
- Ice Gun
- MagLev Train or MagLifter
- Coilgun
- Railgun
- Laser and Microwave Rockets
- Nuclear Rockets
- Launch Loop
- Slingatron
- Geomagnetic Levitation

### 2.4.1 Electrothermal Ramjet

This concept is a member of the class of hybrid electromagnetic-chemical catapult launch systems. In this concept, tungsten projectiles fly in a ceramic tube filled with hydrogen gas and closes a high-voltage circuit (Wilbur et al., 1983; Shaw et al., 1985). An electric current flowing in tungsten foil brushes raises the temperature and pressure of the gas. The maximum muzzle velocity reached by the projectile is unknown. The estimated minimum system mass needed to launch a 1-ton payload is  $10^5$  tons. This system is as power hungry as the railgun (Section 2.4.8). The cost of generating and controlling the enormous electrical power is prohibitive. Rails guiding the projectile are eroded by direct physical contact with the projectile (see Section 2.4.8 for a discussion on this theme).

Another version of this concept is the electrothermal rocket. This is a tungsten rocket that is propelled by hydrogen gas, which is heated by electric current. The rocket carries all of the hydrogen. Two parallel rails provide the electric power. The rocket flies between the rails and closes a high-voltage circuit. The estimated specific impulse ( $I_{sp}$ ) is  $\approx 918$  seconds. The maximum velocity is determined by the mass of hydrogen carried by the rocket. The estimated minimum system mass to launch a 1-ton payload is  $10^5$  tons. The power requirements and rail erosion of this system are similar to the electrothermal ramjet and railgun. This concept has no bibliography available with which to make further analysis and evaluation possible.

The system cost, complexity, wear and tear problem, and power requirements make this concept undesirable. We will not consider it further.

## 2.4.2 Explosive Accelerators

This concept is a member of the class of chemical catapult launch systems also known as explosive or blast-wave accelerators. The author has chosen this concept as a recommended advanced propulsion concept. A detailed description of the concept is provided in the next chapter.

## 2.4.3 One- and Two-Stage Light Gas Guns

This concept is another member of the class of chemical catapult launch systems. A one-stage light gas gun shoots a projectile consisting of a two-stage rocket and payload (Eder, 1981; Powell, et al., 1986; Tidman and Massey, 1993; Bertolini et al., 1993). The gun replaces the first stage rocket. The projectile is propelled by hot, compressed light gas (helium), which is allowed to enter the gun barrel and expand to accelerate the projectile at g-loads comparable to those of cannons ( $\approx 10,000 - 40,000 g$ ,  $1 g = 1 \text{ Earth gravity} = 9.81 \text{ m/sec}^2$ ). Sequential side injection of the helium can be used to reduce the peak pressure in the gun to  $\approx 1,000$  atmospheres.

The major components of the system are its pump and launch tubes. In the pump tube, a piston is accelerated by means of a compressed driver gas released out of a high-pressure gas reservoir, or by a combustion process behind the piston. The expanding driver gas accelerates the piston down the pump tube. In front of the piston is the actual launch gas, which is being compressed by the piston. When a certain pressure level is reached, a diaphragm between the pump and launch tube or a coupling holding the projectile breaks and the launch gas expands into the launch tube, thus driving the projectile toward the muzzle. Rail-mounted counter-masses absorb the recoil of large-scale gas guns. Design concepts involve the continuous injection of the launch gas through multiple ports aligned with the launch tube, thus reducing initial high-pressure requirements, lowering peak acceleration of the projectile, and maintaining a more constant-base pressure history.

The maximum muzzle velocity of the projectile is limited to the speed of sound in hot helium ( $\approx 2 \text{ km/s}$ ). Additional heating of the helium prior to launch, by either an electric arc pulse or contact with hot particles, will increase the maximum muzzle velocity. The estimated minimum system mass to launch a 1-ton payload is  $10^4$  tons. A variant of this concept is a steam gun that shoots the projectile by using a shock-compressed steam-heated propellant mixture of hydrogen and oxygen (Seigel and Slawsky, 1956).

In a two-stage light gas gun concept, a combusting mixture of air and natural gas propels a heavy piston (Crozier and Hume, 1957; Taylor, 1987; Hunter and Hyde, 1989; Henderson, 1990; Bogdanoff and Miller, 1995). The piston compresses and heats hydrogen gas. The hydrogen is released into the launch tube when a metal diaphragm ruptures under pressure. The diaphragm is scored so that it fails in a predictable fashion. A nylon sabot propelled by the hydrogen carries the projectile. The sabot reduces abrasion and makes it possible to use low hydrogen pressure and a slender projectile. The maximum muzzle velocity of the projectile is limited to the speed of sound in hot hydrogen ( $4 \text{ km/s}$ ). The estimated minimum system mass to launch a 1-ton payload is  $10^4$  tons.

A hybrid variant of this concept is called the ram accelerator, whereby a projectile resting on a sabot is fired from a one- or two-stage light gas gun into an accelerator launch tube (Hertzberg et al., 1988; Kaloupis and Bruckner, 1988; Bogdanoff, 1992; Bogdanoff and Higgins, 1996; Knowlen and Bruckner, 2001). The accelerator launch tube is a steel tube filled with a pressurized mixture of fuel and oxidizer (such as methane, oxygen, nitrogen, etc.). The projectile compresses the mixture to the point of ignition, and the mixture expanding behind the projectile generates thrust. A variant of this is the hydrogen core ram accelerator, which comes in four versions depending on how the hydrogen gas and fuel mixture are kept separated in the accelerator launch tube. In this hybrid variant, a steel tube is divided into two parts in which the inner part near the tube axis is filled with hydrogen gas while the outer part is filled with a mixture of fuel, oxidizer and diluent. The four versions are the balloon ram accelerator, gas vortex ram accelerator, laminar ram accelerator, and powder vortex ram accelerator. The first version uses a disposable balloon to separate the hydrogen gas from the fuel mixture in the tube. The second version uses turbulent vortex motion to separate fast-flowing hydrogen gas and fuel mixture in the tube. The third

version uses laminar flow in a vertical launch tube to separate the slow-flowing hydrogen gas and fuel mixture. And the last version uses vortex motion to separate the hydrogen gas and fuel mixture in the tube, and ammonium nitrate is used as the oxidizer. Ram accelerators suffer from ablation, premature detonation of the fuel mixture in front of the projectile, and erosion of the projectile and tube due to the physical contact between them.

In the light gas gun concepts and their variants, the requirement for both modest acceleration ( $< 10\text{ g}$ ) and large payloads has a significant cost impact because of the need for a long and large-diameter high-pressure barrel. This concept will not be considered further since its complexity and cost increases with increasing payload size and decreasing acceleration, and some unresolved technical issues make it inferior to the concept in Section 2.4.2.

#### **2.4.4 Vortex Gun**

This concept is another member of the class of chemical catapult launch systems. In this concept a projectile (made of W-Re-Hf-C to withstand high temperatures) is placed inside a disposable winged sabot, which resembles a very slender glider plane. The sabot is propelled by a light molecular-weight gas (hydrogen) flowing across a multitude of short wings attached to the sabot. The gas flows transversely to the direction of projectile motion. The gas flow is generated by either unloaded balloon guns or by opening explosively driven gate valves, or by combusting a mixture of hydrogen and oxidizer (such as oxygen or fine-powder ammonium nitrate). The gun operates at room temperature and is free from corrosive chemicals or abrasion, and there is no physical contact between the sabot and the gun barrel. The maximum muzzle velocity is approximately five times the speed of sound in the gas (Higgins, 1997). The estimated minimum system mass required to launch a 1-ton payload is 1,000 tons. Vortex guns have two other versions, called the spiral gas gun and vortex accelerator.

In the former concept, hydrogen gas flows in two-dimensions, and fins inside the gun force a helical flow of the driver gas. The interaction between five rows of short wings attached to the sabot and the helical gas flow propels and stabilizes the sabot. The gate valves in this system have a critical 1-millisecond timing tolerance for a 10-meter long glider. And the need for a very large number of precisely timed gate valves is a single design fault for this concept.

The latter concept combines a powder vortex ram accelerator with the vortex gun. In this concept, a mixture of hydrogen and fine-powder ammonium nitrate is pumped through the accelerator. The premature detonation of the mixture is prevented by helical ribbons, which force it into a vortex flow. The projectile has several rows of flexible wings attached, which are feathered unless gas pressure deflects them. The projectile compresses the hydrogen-ammonium nitrate powder mixture into ignition, and is subsequently propelled by the vortex flow of the combusting mixture. The ammonium nitrate powder in the center of the tube burns in the hot, thin boundary layer that forms on the projectile's nose cone.

This concept also suffers from system sizing and cost problems related to the payload size and acceleration. There is no significant bibliography available with which to make a proper analysis and evaluation for this concept. Therefore, it will not be considered further.

#### **2.4.5 Ice Gun**

This concept is another member of the class of chemical catapult launch systems. The ice gun is a 1,000 km long hydrogen-filled tunnel cut through the Antarctic ice sheet. The three versions of the ice gun are chemical, nuclear and balloon.

In the chemical ice gun, the tunnel is divided into the breech, vacuum, middle and muzzle compartments. A barbell-shaped projectile is accelerated in the vacuum compartment by hydrogen that is stored in the breech compartment. The middle compartment is also filled with hydrogen, except for a series of cavities that are filled with an explosive mixture of oxygen and hydrogen. As the projectile moves through the middle compartment, it ignites the mixture and generates thrust in a fashion similar to



a ramjet or a two-stage light gas gun. The projectile generates thrust as a liquid rocket-in-tube or as a solid rocket-in-tube when it enters the muzzle compartment at 4 km/s.

In the balloon ice gun, a projectile is accelerated by fast-flowing hydrogen gas that is released by a multitude of unloaded balloon guns. The nuclear ice gun is a nuclear-powered ramjet. The ramjet accelerates its payload to 9 km/s, drops off, decelerates, stops, and picks up another payload.

The estimated minimum system mass required to launch a 1-ton payload is 100 tons (not including the ice). The operational cost for this concept is 1% of conventional rocket launch costs. Projectile-payload accelerations are low enough for the payload to carry people. The ice sheet flows at 10 meters/year, and this will cause deformation of the tunnel. To avoid this, the tunnel must be excavated in nearly stagnant ice. There is also the problem of the gradual collapse of the tunnel due to stress within the ice. However, the polar ice is melting due to global warming. Therefore, this concept is unfeasible. We will not consider it further.

#### **2.4.6 MagLev Train or MagLifter**

This concept is a member of the class of electromagnetic catapult launch systems. This concept involves a superconducting magnetic levitation (MagLev) train or lifter to accelerate a SSTO launch vehicle to a velocity of 0.3 km/s inside a tube or tunnel (Nagatomo and Kyotani, 1987; Scott, 1995). The vehicle is then released from the train and flies to LEO in a conventional way, whereby the SSTO propulsion system provides the additional  $\Delta v$  (8.7 km/s) needed to get to orbit. The consequence of this is that the vehicle final (dry) mass will be 13.9% of the initial wet mass, whereas it is normally  $\leq 13\%$  of the initial wet mass for an SSTO using SSME-type propulsion. This 6.9% increase in delivered mass to orbit provides room to carry additional payload mass, or to reduce the development and construction costs by using cheaper conventional propellant tankage. The velocity increase provided by this catapult is greatest when the exit angle is  $\approx 45$  degrees, and when the altitude at the track exit (with respect to the tunnel entrance) is  $\geq 3$  km to minimize the effects of atmospheric drag.

The MagLev train is essentially a very long asynchronous linear motor intended for transportation of payloads. The conductive train is accelerated by a quickly changing magnetic field produced by stationary coils. This concept provides a small portion of the required total Earth-to-orbit  $\Delta v$ . However, with its acceleration of  $< 3$  g, the MagLev is able to use conventional stages and payloads and accrue cost savings even with a low muzzle velocity.

The system is built inside a mountain and consists of a superconducting catapult guideway, a tunnel enclosure ( $\approx 4$  km in length) with a disposable membrane to maintain an interior vacuum, and electrical power for the superconducting electromagnets (cooled by liquid nitrogen) that levitate and propel the train/lifter (a.k.a. sled) along the guideway. The vehicle exits the track at Mach 1, and the altitude of the exit is  $\geq 3$  km, and its angle to the horizontal is 45 degrees. There is a decelerator guideway (a.k.a. run-out section) at the end of the track, which is used to decelerate and return the empty train/lifter.

MagLev technology is relatively mature and is the same as that developed for high-speed trains, and it appears well suited for the size and acceleration requirements of piloted mission payloads. The estimated minimum system mass required to launch a 1-ton payload is  $10^6$  tons. The power requirements for this concept are less demanding than for a short coilgun. The cost of the electricity required to power the catapult is  $< \$2/\text{kg}$  of payload. There are technical issues that need to be solved before this concept can be demonstrated. The most important of these are the development of the disposable membrane for maintaining the launch tunnel vacuum, the development of a large-scale high reliability vacuum system for the tunnel enclosure, and the development of a large-scale high reliability cryogenic cooling system for the superconducting coils and guideway inside the tunnel. Another important issue is that the launch vehicle has to be somehow integrated with the train, and a means for its separation without rebound and possible contact with the train at transonic velocities needs to be developed. Furthermore, the cost of excavating a precision vacuum tunnel possessing an upward inclination through a mountain is similar to the cost of excavating the Yucca Mountain Nuclear Waste Repository north of Las Vegas, NV, or  $\approx \$58 -$

100 billion, since state-of-the-art mountain tunneling technology used for the waste repository can be applied to the MagLev project. It has been determined that this concept will require another 20 years before it can be developed and demonstrated. We will not consider this concept further only because it is already a NASA advanced propulsion concept R&D program (that was originated by the AFRL in the early 1970's).

#### **2.4.7 Coilgun**

This concept is another member of the class of electromagnetic catapult launch systems. The coilgun (a.k.a. electromagnetic mass driver) is a direct adaptation of a linear synchronous motor that operates through the inductive reaction between stationary stator coils and a coaxial conducting armature that is attached to a projectile or a reusable bucket that carries the projectile (Clarke, 1950; Reid, 1972; Kolm and Thornton, 1972; Thornton, 1975; Arnold et al., 1979; Schroeder et al., 1989; Palmer and Lenard, 1991; Lipinski et al., 1993; Bresie et al., 1995). A large number of stator coils are stacked to form a gun barrel, and are energized sequentially by computer-triggered switches and capacitors, thus accelerating the projectile. The reusable bucket or projectile moves through the gun barrel like a surfboard riding the forward crest of a magnetic traveling wave, whereby the wave is generated by the drive coils and synchronized by position sensors. A plasma window or disposable vacuum seals separates the vacuum inside the gun barrel from the outside atmosphere in order to minimize air drag on the bucket/projectile while it accelerates through the barrel. The reusable bucket significantly reduces the cost of launching each projectile. After each bucket releases its payload, it is decelerated, and returns to be reloaded with a new projectile/payload and re-launched.

There is an axial gun configuration that permits very high electrical efficiency and acceleration, whereby the projectile is required to be cylindrically shaped. A planar configuration can accommodate projectiles with any arbitrary shape. A superconducting version of this concept is called the quench gun in which it is possible to generate a traveling wave of magnetic field gradient by successively quenching a line of adjacent coaxial superconducting coils forming a gun barrel. A superconducting armature coil attached to the projectile or reusable bucket will ride this wave like a surfboard. In this scheme, the propulsive energy is stored directly in the drive coils, and the electrical efficiency is > 90%. The superconductors used in the coils improve system efficiency by eliminating the  $I^2R$  losses. A scheme using a superconducting coilgun driven in a high pulsed-power mode was proposed by Schill and Davis (2003).

Accelerations of 100,000 – 250,000 g are theoretically possible. However, only small, low velocity, low acceleration laboratory-scale devices have been demonstrated with projectiles of a few hundred grams. Also, the experimental scale-up for space transportation applications has not yet been addressed. There is no practical technical limit to the launch velocity and length of the barrel in coilguns, but performance is ultimately limited by thermal and mechanical failure of the drive coils, along with the voltage and current limitations of the silicon-controlled rectifiers used for switching. The failure mode of superconducting drive coils operating under fast pulse conditions is a subject requiring experimental study. There is also the problem that magnetic friction at the end of the muzzle drags down the muzzle velocity of the projectile by several percent, and this has not yet been solved.

A coil gun will have to be a very large, complex, power-hungry device requiring rapid switching of large amounts of power in order for it to launch space transportation sized payloads. A 10-ton projectile will require switching electrical power at several hundred kilovolts in the stator coils. This will require a large dedicated power plant and energy storage system. The quenched coils in a superconducting coilgun generate a great deal of heat, and thus a cryogenic refrigerator to remove the heat would have to be scaled so large that such a gun cannot be applied to space transportation. No experimental tests have been done using superconducting (high-temperature type) drive coils and armatures. The estimated minimum system mass required to launch a 1-ton payload is  $10^5$  tons. This concept will not be considered further.

## **2.4.8 Railgun**

This concept is another member of the class of electromagnetic catapult launch systems. In this concept, two parallel rails are connected to a DC current source. A projectile consisting of a short-circuit slide moves along the two conductive rails and closes the electrical circuit. The electrical current flowing in the circuit is tremendous, and it generates a magnetic field that induces a Lorentz force, which accelerates the projectile (Brast and Sawle, 1965; Rashleigh and Marshall, 1978; Hawke et al., 1981; IEEE, 1995). Payloads are thus subjected to extreme accelerations in this scheme, and an experimental demonstration achieved a 2,000 g acceleration of a 1 kg mass. A 16 gram mass was later accelerated to 250,000 g along a 5 meter rail to a muzzle velocity of 5.9 km/s.

Rail erosion is severe in this concept because direct contact between the projectile and the rails ablates both of them. There is also high brush current density and related metal vapor arcs that generate destructive corrosion effects leading to further ablation of metal components. The ablation produces plasma, which short-circuits the rails and limits the maximum muzzle velocity to 6 km/s. The experimental and theoretical database available from the study of electrical contact components (brushes, etc.) and circuit breakers does not extend to the current densities and projectile velocities in railguns. Tidman et al. (1993) propose filling the railgun with hydrogen gas as a way of mitigating ablation and corrosion. Another design problem relates to the mechanical containment of the percussive expansion force, which tends to blow the rails apart.

The practical limit of railgun performance in regard to projectile size, acceleration, length of the gun and maximum muzzle velocity is still being explored. The fundamental performance limits are strongly driven by the maximum possible gun length or maximum muzzle velocity. The lengthening of a railgun results in a very large fraction of the propulsive energy being absorbed by the resistance and inductance of the rails. Also, an increase in the projectile velocity causes an increasing back-EMF, whereby current will continue to flow even if this EMF exceeds the output voltage of the motor (because the intermediate storage inductor acts as a current source). There is also the practical limit to the voltage that can be stood-off by the gap between the rails, which scales linearly with gun length. The demand for electricity to power this system is astronomical, and the cost of power control switches is prohibitive (> \$1 billion per ton of payload).

Service life and acceptable cost are, therefore, the major drivers of the practical performance limit of this concept. There are also the augmented and segmented railgun designs, which have special modifications to mitigate a few of the basic railgun problems. However, there is no significant bibliography available with which to make further analysis and evaluation of these design modifications possible. The estimated minimum system mass required to launch a 1-ton payload is  $10^5$  tons. The system cost, complexity, wear and tear problem, and power requirements make this concept undesirable. This concept is will not be considered further.

## **2.4.9 Laser and Microwave Rockets**

The author has chosen this concept as a recommended advanced propulsion system. A detailed description of the concept is provided in the next chapter.

### **2.4.10 Nuclear Rockets**

The author has chosen this concept as a recommended advanced propulsion system. A detailed description of the concept is provided in the next chapter.

### **2.4.11 Launch Loop**

This concept is a hybrid electromagnetic catapult launch system. In this concept, a closed loop of laminated iron ribbon is continuously launched to space by an asynchronous linear motor (Lofstrom,

1985). The motor is comprised of a number of high-frequency electromagnets that produce an undulating magnetic field, which moves at 14 km/s (slightly faster than the loop itself). The loop returns to Earth at a location 2,600 km away from the first motor, and is accelerated by another motor and deflected back into space by a magnet. Payloads are transported around the loop by MagLev trains that ride on the loop. Aerodynamic drag is reduced by a sheath that surrounds the loop. However, the loop can be damaged by wind, icing and lightning. The estimated minimum system mass required to launch a 1-ton payload is  $10^4$  tons. There is no other technical information available for this concept. The complexity, wear and tear problem, and power requirements make this concept undesirable. This concept will not be considered further.

#### **2.4.12 Slingatron**

This concept is another hybrid electromagnetic catapult launch system. The slingatron consists of a spiral steel tube with numerous distributed drive motors that cause the entire tube to gyrate around a circle of small radius with a constant gyration frequency (Tidman, 1996, 1998, 2001; Tidman et al., 1996a, b). The device transfers stored inertial energy directly into projectile kinetic energy with no intermediate steps. Work is done on a projectile sliding through the spiral because the accelerator tube is continually pulled inward at the projectile location against the centrifugal force of the projectile. The accelerating force experienced by the projectile (similar to a Coriolis force) is proportional to the projectile's mass. As the projectile swings out around the spiral into turns of increasing radius ( $R$ ), it also maintains phase stability with the small-radius gyration of the entire tube. This phase locking enables the projectile to move out around the spiral turns with the same frequency  $f$  so that its increasing velocity is approximately  $2\pi fR$ .

Tidman (2001) compares the dynamics of the system to a conventional sling in which a mass is whirled around at the end of a string. But the string length is increased so that the whirling frequency remains constant as the projectile velocity increases. No gun injector is required. This system is still in the conceptual development phase, but it can potentially launch a payload to 9 km/s. It is complex and massive, but it requires less electrical power than the railgun or the coilgun. However, it suffers from a number of air drag and mechanical friction problems. The estimated minimum system mass required to launch a 1-ton payload is  $10^4$  tons. The engineering-physics for this concept is still not mature enough for one to be confident in its performance characteristics and promise as an innovative advanced concept. It is the author's opinion that further design studies and experimental work needs to be done to compile detailed performance data before this concept can be seriously considered. Therefore, it will not be considered further.

#### **2.4.13 Geomagnetic Levitation**

This concept is another hybrid electromagnetic catapult launch system. It entails a superconducting cable that is anchored to the Earth, and which carries an extremely high electric current density (Moss, 1989). The cable is levitated via a Lorentz force generated by the Earth's magnetic field. The payload is transported into space via an elevator that is attached to the middle of the cable. This concept is impractical because no existing superconductor can carry the required current density, and the cable would have to be more massive than the Earth unless it is built with Buckytubes. Wind, icing and lightning can break the cable and render the system inoperable until repaired. There is not enough literature published to better grasp this concept's performance parameters and functional requirements. Therefore, this concept will not be considered further.

## Chapter 3 – The Recommended Advanced Propulsion Concepts

### 3.1 The Final Selections

This chapter reviews and summarizes the advanced propulsion concepts the author has chosen as finalists for recommendation to the AFRL Propulsion Directorate. The criteria used to make the final selections are completely based on the advanced concepts guidelines described in Section 1.3.

### 3.2 Explosive Accelerators: The Blast-Wave Accelerator

Explosive or blast-wave accelerators are a member of the class of chemical catapult (artillery gun type) launch systems. In explosive accelerators, a projectile is accelerated either by a high explosive or by hydrogen gas that is compressed by an explosive (Wenzel and Gehring, 1965; Wenzel, 1987). Explosives such as Composition B, Octol, RDX, HMX9404, LX-10 and PBX 9010 are used for their high detonation velocities of 7 – 9 km/s. Examples of this concept include the air cavity launcher, the shaped-charge detonation launcher, the Voitenko implosion gun, and the blast-wave accelerator. The air cavity launcher uses a high explosive to accelerate a small projectile to 5.5 km/s (Clark et al., 1960; Kineke, 1960). The shaped-charge detonation launcher uses a high explosive to implode a conical metal liner, whereby the implosion fuses the liner into a thin liquid jet that accelerates a projectile to 16.5 km/s (Wenzel and Gehring, 1965). And the Voitenko implosion gun uses a high explosive to accelerate hydrogen gas, which in turn accelerates a thin disk to 40 km/s (Voitenko, 1964; Sawle, 1969).

The blast-wave accelerator is chosen as a recommended advanced propulsion concept because of its simplicity and very low system cost. Projectiles are accelerated by a series of hollow explosive rings that are detonated in rapid sequence causing a near-constant pressure to form at the base of the projectile, thereby generating a near-constant and large acceleration (Moore et al., 1965; Rodenberger, 1969; Rodenberger et al., 1970; Bakirov and Mitrofanov, 1976; Voitenko, 1990; Tarzhanov, 1991; Kryukov, 1995; Carrier et al., 1995; Tan et al., 1996; Takayama and Sasoh, 1998; Wilson and Tan, 2001). The gun can have a barrel (launch tube) or explosive rings that are supported by a top beam via inertial confinement (see Figures 4 and 5). The gun's structure is simple since the principal change required to reload the gun is the replacement of the explosive rings and rudimentary structure. Plastic foam is used in steel launch tube designs to protect the tube from the explosion, and hydrogen gas flows near the tube axis. There are disposable designs that forgo the plastic foam in order to achieve higher hydrogen gas pressure. The projectile accelerations produced by a blast-wave accelerator are moderate compared to the other explosive accelerators. Payloads can have an apogee kick motor attached to circularize their trajectory and enter orbit. The overall system has nominal-to-low cost operation.

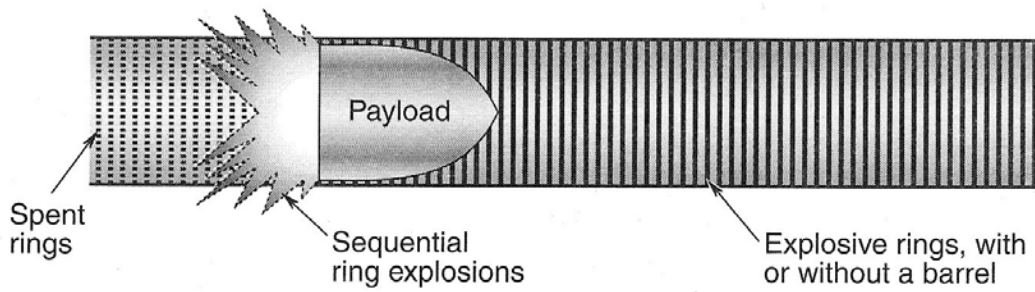
We outline below the salient features of the blast-wave accelerator (Bekey, 2003):

- This system is a one-stage gun launcher, which can directly place payloads into orbit
- This is a lower-cost launch system that can orbit small dense payloads or multiple modules designed to be assembled in orbit
- This system can launch commodities and small spacecraft with electronics
- This system can ballistically deliver a warhead (oriented projectiles or explosives, undersea homing torpedoes, etc.) or payload anywhere on the globe:
  - it can be used as a precision strike weapon with global reach
  - it can achieve strike precision at near-orbital speed

- it has artillery-like operations, complexity and cost
  - it can be based anywhere
  - it possesses excellent stealth (i.e., it has no exhaust plume)
  - it has affordability, ferocity, and quick reaction time
- The Blast-Wave Accelerator:
    - is of Russian origin
    - is a concept that has been verified by NASA studies
    - is state-of-the-art technology
  - Estimated launch cost: \$200 – 2,000/kg of payload, depending on construction and refurbishment options
  - 15 m barrel generates 300,000 g acceleration
  - 40 m barrel generates 100,000 g acceleration
  - Longer barrel generates lower launch acceleration
  - Russian experiments indicate that Mach 27 projectile/payload velocity is achievable
  - Payload mass fraction is 70 - 95%

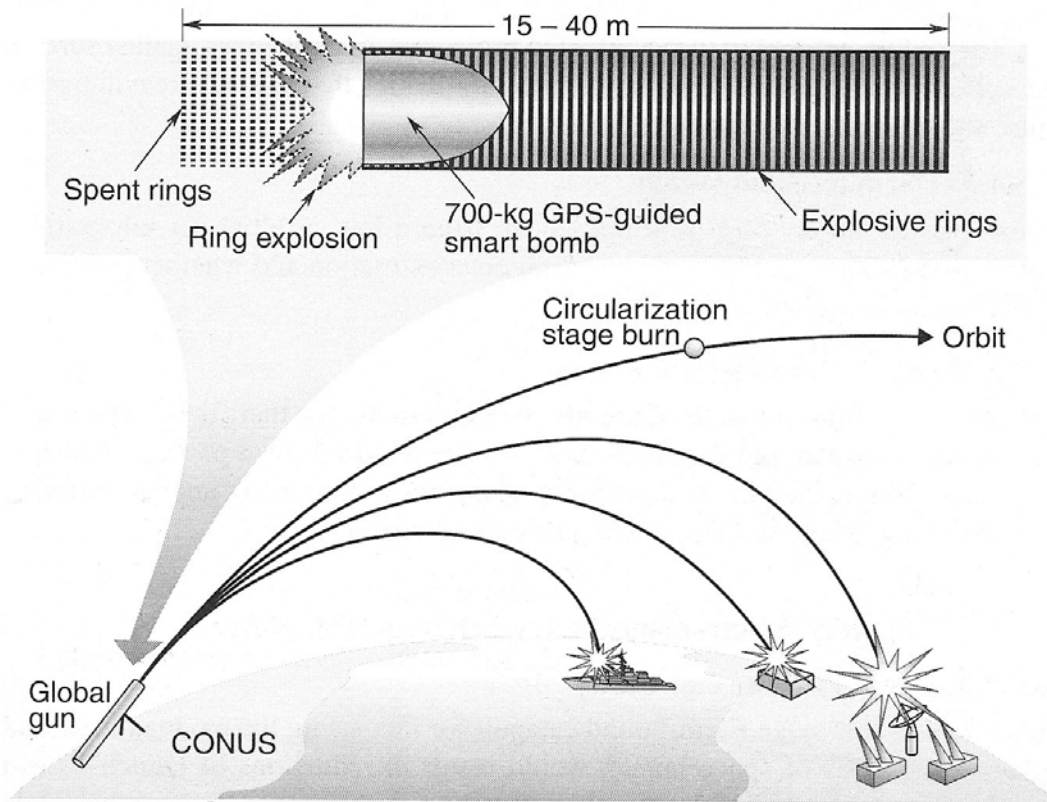
It should be noted that experiments have demonstrated that electronic circuits and components (including vacuum tube electronics) can withstand accelerations up to and above 100,000 g and continue to function.

This is an overlooked, promising near-term concept. It does not require the development of new technology or technology risk reduction. This concept has not been in development for reasons involving politics, agenda, legacy, or simple resistance to different ways of doing things. This concept possesses substantial unrealized benefits and it can be implemented right now to meet most unmanned mission requirements.



- Blast wave accelerator
- Series of explosive rings
- Rings detonated in precise sequence
- Essentially constant acceleration
- 15-m barrel results in orbital velocity at 300,000 g's
- 40-m barrel reduces to 100,000 gravity
- Russian experiments indicate Mach 27 achievable
- Suitable for dense payloads or commodities

**Figure 4. Schematic of the Blast-Wave Accelerator (Bekey, 2003)**



**Figure 5. The Blast-Wave Accelerator Can Launch Payloads Into Space Or Deliver Weapons Anywhere On The Globe From CONUS (Bekey, 2003).**

### **3.3 Beamed-Power Propulsion: Laser and Microwave Rockets**

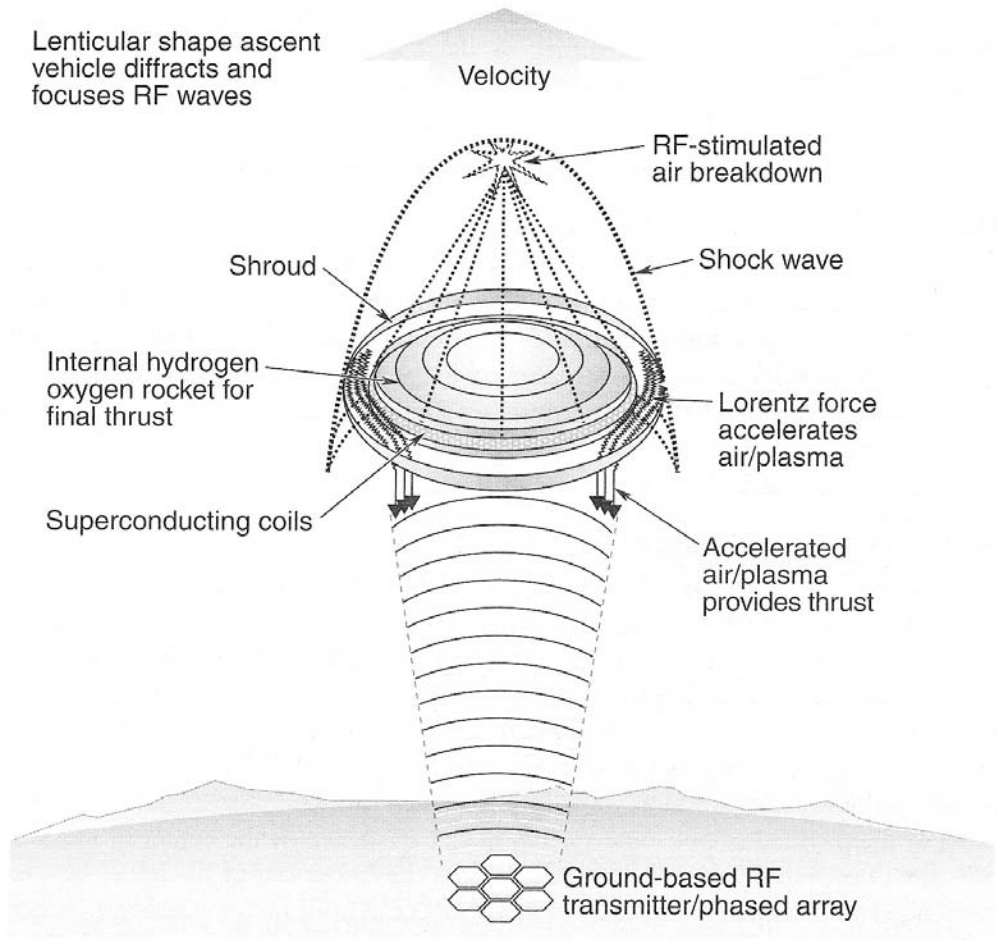
This is the class of beamed-power propulsion launch systems. Laser and microwave propulsion is a new and exceptional method for reaching space. By launching spacecraft on a beam of electromagnetic radiation, researchers will have developed the first new method of achieving orbit since the late 1950's. In this concept, a remote or ground-based energy source, such as a ground- or space-based microwave or laser beam generator, transmits power to a spacecraft via a beam of electromagnetic radiation (Forward, 1962; Kantrowitz, 1972; Rom and Putre, 1972; Minovitch, 1972; Pirri and Weiss, 1972; Harstad, 1972; Pirri et al., 1973; Roschke, 1975; Vetter, 1975; Myrabo, 1982, 1983; Glumb and Krier, 1984; Myrabo and Ing, 1985; Myrabo, 1986; Walton et al., 1989; Birkan, 1992; Benford and Swegle, 1992; Myrabo and Benford, 1994). The spacecraft collects the beam energy and uses it to power the propulsion system. This concept has the advantage of using the ambient air as the working fluid in the atmosphere and carrying propellant only for use outside the atmosphere, leaving the energy source for heating the propellant on the ground. This results in a tremendous weight reduction and improved performance benefit for the spacecraft because a large propellant mass and heavy energy source are not carried on-board. There are six variations and a smaller number of sub-variations of this concept, but we will focus on only two of them for the purpose of this study. The two versions we are recommending in the study are the RF-powered electromagnetic lenticular craft and the laser-powered lightcraft.

#### **3.3.1 RF-Powered Lenticular Craft**

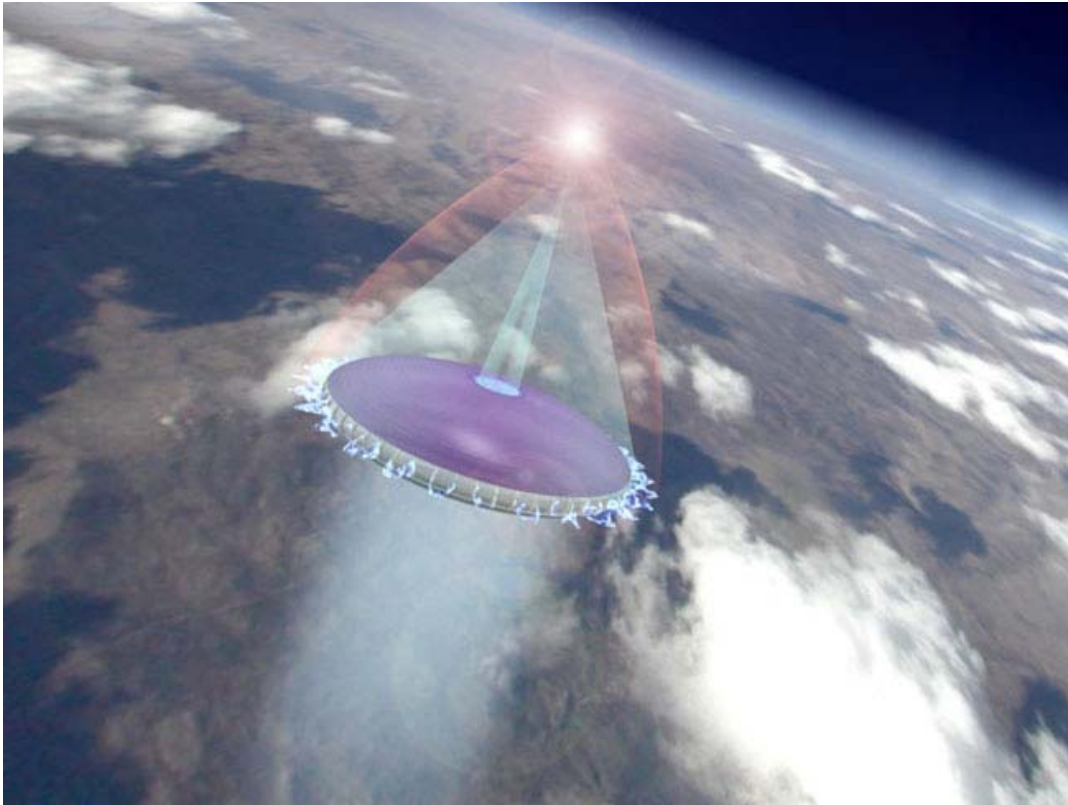
The RF-powered lenticular craft flies on a beam of microwave or mm-wave energy. The RF energy is beamed from a ground generator to the launch vehicle, which is designed to harness the beam energy and convert it into propulsive thrust (Benford and Swegle, 1992; Myrabo and Benford, 1994; Bekey, 2003). The beamed energy diffracts around the lenticular-shaped launch vehicle, and is focused at a point ahead of the vehicle creating atmospheric breakdown (ionized air) at that point. The resulting ionized air flows downward around the vehicle and is accelerated by superconducting coils at its base using MHD forces. The accelerated air is ejected through nozzles located along the periphery of the vehicle's base, thereby producing downward (vertical) thrust like a jet engine. Multiple superconducting coils are used in groups around the periphery of the craft to allow hovering and sideways (helicopter-like) translation. The superconducting coils act together to propel the vehicle to orbit. This craft is spin-stabilized and can launch vertically upward or on a slant upward trajectory, hover in mid-air, and undergo powered descent and landing (see Figures 6 and 7). The ground-based RF beam generator system consists of the following:

- Power supply
- High-power (GW-class) micro- or mm-wave beam generator and transmitter
- Phased array antenna to form and propagate a narrow beam to the craft
- Automated tracking, hand-off and safety systems





**Figure 6. The RF-Powered Lenticular Craft (Bekey, 2003)**



**Figure 7. The RF-Powered Lenticular Craft Ascending To Orbit (From [www.Space.Com](http://www.Space.Com))**

### **3.3.2 Lightcraft**

The laser-propelled vehicle, called “lightcraft” because it flies on a beam of laser light, is designed to harness the energy of a laser beam and convert it into propulsive thrust. In the earliest laser-propelled rocket designs, beamed energy from a ground-based laser (with near-visible wavelengths) is absorbed by a heat exchanger on board a rocket, and is transferred to a working fluid. The heated fluid (hydrogen, ammonia, etc.) then produces thrust by expansion through a nozzle as in a conventional chemical rocket. An alternative to this scheme is to use the beamed-energy to ablate an on-board solid propellant (such as Delrin) to generate thrust. However, a more recent incarnation of this concept is for the lightcraft to operate in two propulsion modes: airbreathing (detonation wave) and rocket ablation (deflagration). The lightcraft operates in air breathing mode to Mach 5 and 30 km altitude, and in laser thermal rocket mode (using liquid, gaseous, or Delrin ablation propellant) in space (Myrabo, 1982, 1983, 1986; Myrabo and Ing, 1985; Kare, 1987; Walton et al., 1989; Myrabo et al., 1989; Kare, 1990a, b, c; Lawrence et al., 1991; Kare, 1992a, b; Messitt et al., 2000). See Figures 8 and 9. This dual-mode lightcraft propulsion scheme is the version that the author recommends for this study, because it is extremely effective and efficient as an ETO propulsion system.

In this concept, a forebody aeroshell acts as an external compression surface for the airbreathing engine inlet. Affixed to the bottom of the craft is a parabolic-shaped afterbody mirror, which serves as a primary receptive optic for the laser beam and as an external plug nozzle expansion surface. The primary thrust structure is the centrally located annular shroud, which provides air through the inlet and also acts

as a ring-shaped energy “absorption/propulsion” chamber for plasma formation. The air inlet is closed when the lightcraft operates in the rocket mode. See Figures 10-12.

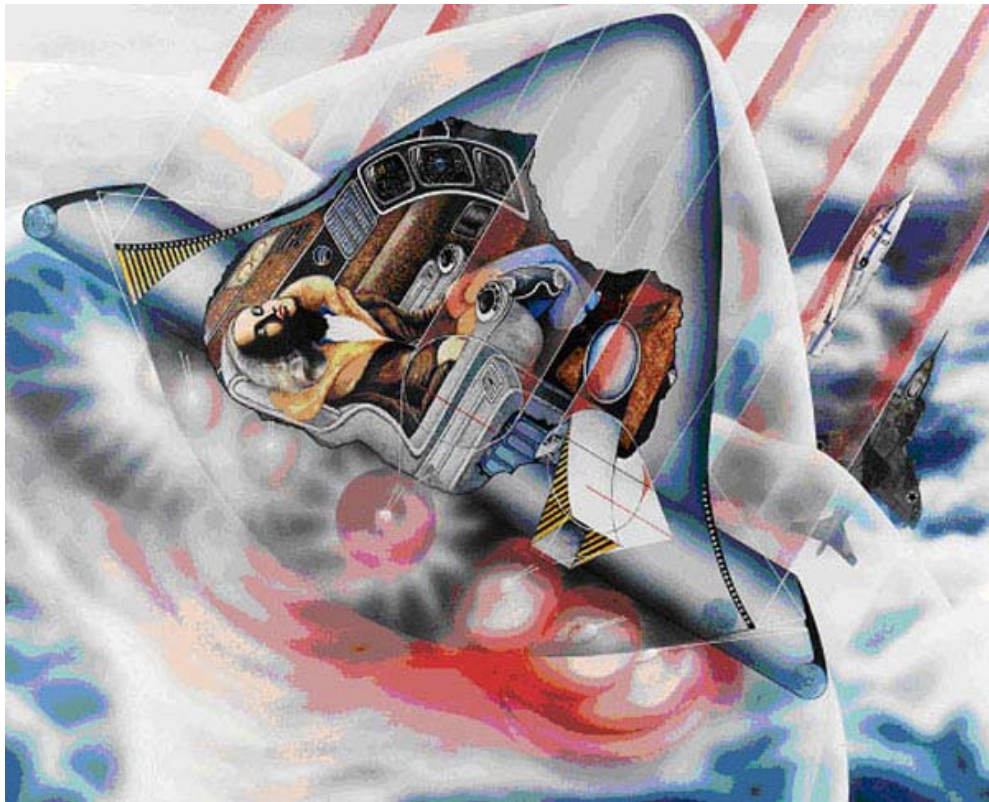
The lightcraft is very lightweight and uses its shape to facilitate vertical flight. The craft has the appearance of a fat acorn when viewed from the side. The lower portion of the craft is a very highly polished metal mirror, whereby the lower point of the acorn-shape is the midpoint of a stretched-out parabolic mirror. The lightcraft receives kilo-Joule pulses from a ground-based infrared laser at a rate of 10 times per second. The axisymmetric, off-axis parabolic collection mirror facilitates flight by concentrating the pulsed laser light into an annular focus. The laser beam’s pulse interacts with the mirror, spreading out and focusing into an annular area inside the circumference of the craft. The intensity of the 18 millisecond pulsed laser is sufficiently high that atmospheric breakdown occurs in the annular area causing inlet air to momentarily burst into a highly luminous plasma (10,000 – 30,000 K), thereby producing a superheated plasma shock wave (with instantaneous pressures reaching tens of atmospheres) that generates thrust in the direction of the laser beam. A lip around the craft’s circumference, akin to a plug nozzle directs the expansion of the plasma, creating downward thrust expansion. Multiple laser pulses and an atmospheric refresh of breakdown air generate the flight. (This airbreathing pulsed-detonation engine concept owes its origins to the German V-1 “Buzz Bomb” of WW II that ran on aviation fuel.)

The airbreathing engine mode develops quasi-steady thrust by pulsing at hundreds to thousands of times a second – depending on the Mach number and altitude flown along the flight trajectory to orbit. Once the lightcraft reaches very high altitude and climbs above the atmosphere, it begins to operate in the thermal rocket mode using on-board (liquid, gas, or Delrin) propellant to convert and expand the laser energy for propulsion. The lightcraft is spin-stabilized and can be launched vertically upward or on a slant upward trajectory, hover in mid-air, and undergo powered descent and landing. The ground-based laser beam generator system consists of the following:

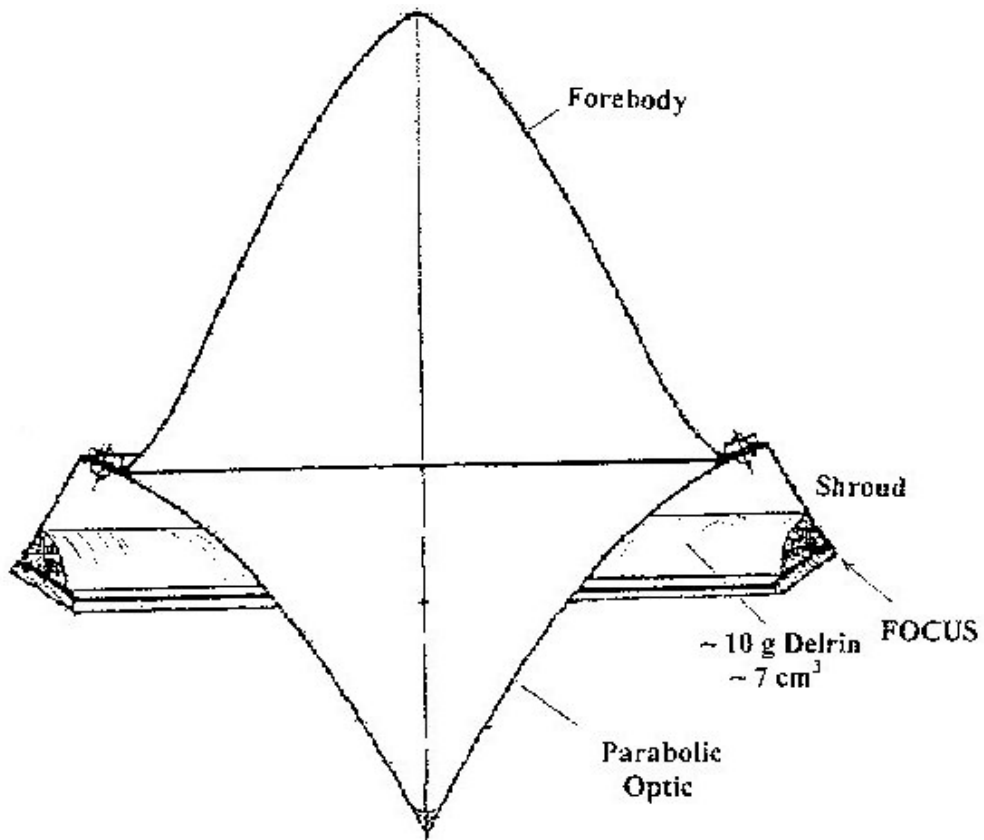
- Power supply
- High-power (MW-class) laser beam generator/transmitter using novel beam optics
- Automated tracking, hand-off and safety systems



**Figure 8. Lightcraft During Launch (From [www.Space.Com](http://www.Space.Com))**



**Figure 9. Lightcraft During Launch (From [www.Space.Com](http://www.Space.Com))**



**Figure 10. Cross-sectional View of Laser Lightcraft Model 200-3/4 (Larson et al., 2002)**

The maximum diameter of the test article at the shroud is  $\approx 10$  cm. The indicated ring of Delrin ablation propellant has a mass  $\approx 10$  g, volume  $\approx 7$  cm<sup>3</sup>, and surface area  $\approx 25$  cm<sup>2</sup>. The idealized maximum plug nozzle exit area is  $\approx 350$  cm<sup>2</sup>.

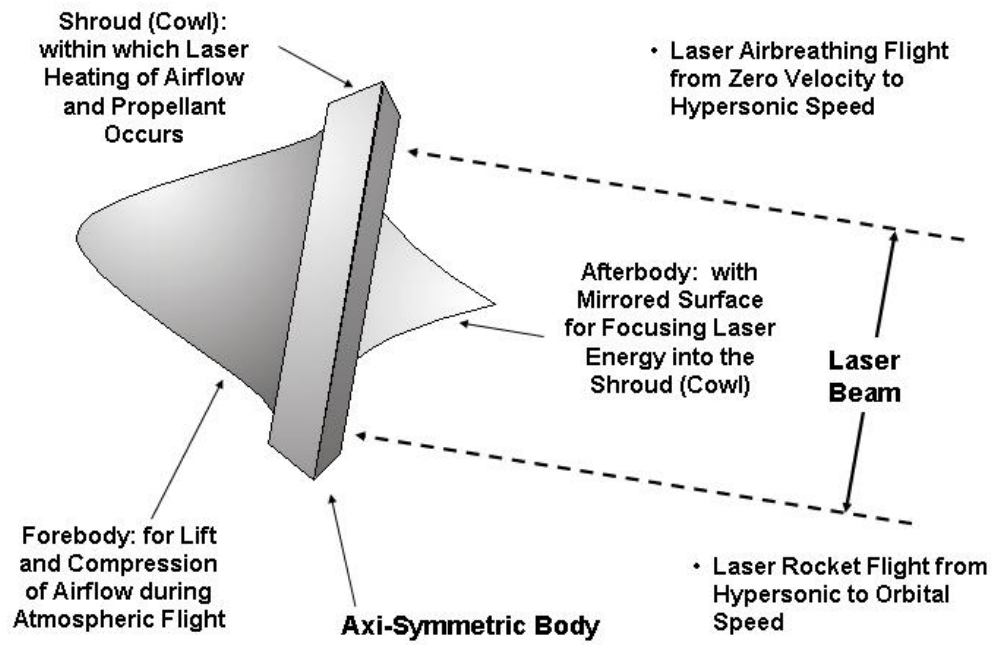
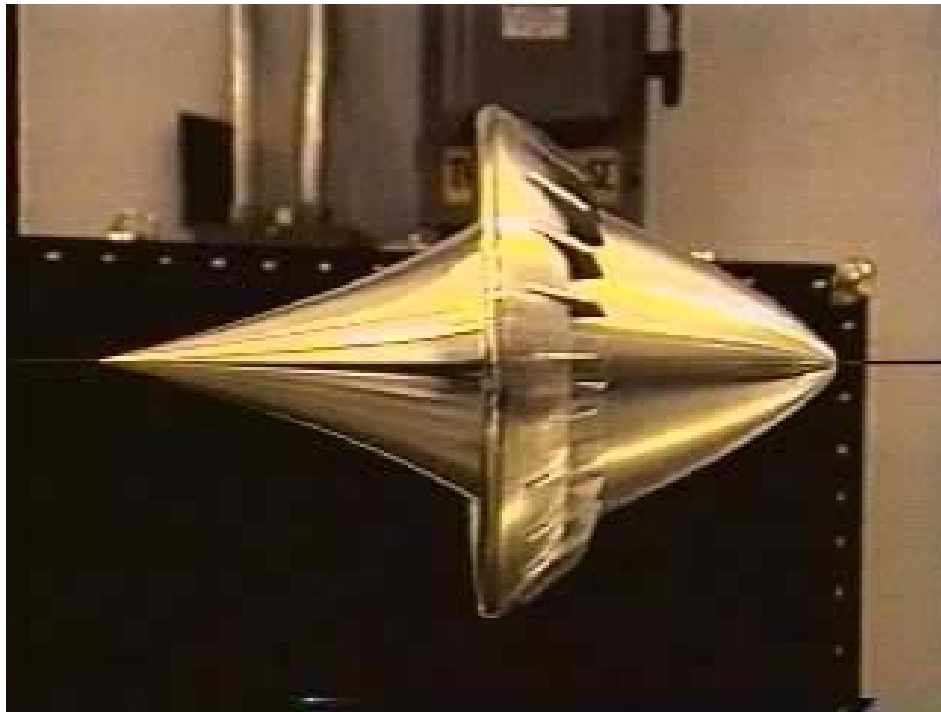


Figure 11. Lightcraft Schematic (Froning et al., 2003)



**Figure 12. Lightcraft Flight-Test Vehicle Used In Horizontal Guide-Wire Flight Tests**  
(From [www.Space.com](http://www.Space.com))

The top of the vehicle is to the right, and the laser beam strikes the stretched-out parabolic mirror/propulsion section on the left.

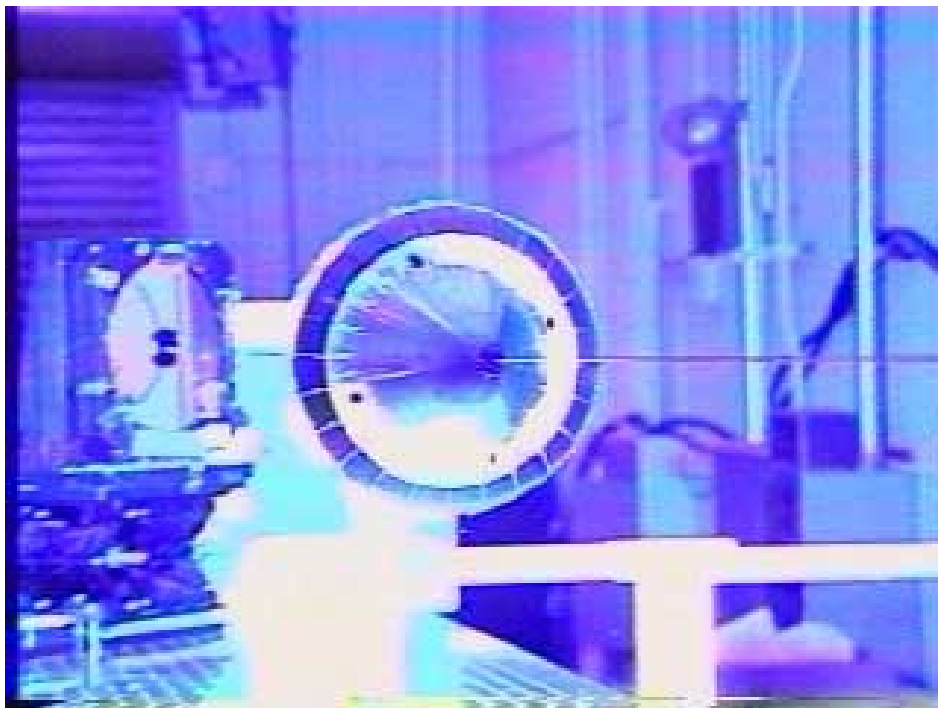
### **3.3.2.a Lightcraft Technology Demonstration Program**

The lightcraft project originally grew out of the Lightcraft Technology Demonstration Program funded by the SDIO Laser Propulsion Program in the late 1980's. In the 1990's a joint program involving the NASA-Marshall Space Flight Center and the Propulsion Sciences and Advanced Concepts Division of the AFRL Propulsion Directorate developed and tested an experiment to determine the feasibility of using high-power pulsed lasers to launch a spacecraft into orbit. Successful tests at the White Sands Missile Range (WSMR) High Energy Laser Systems Test Facility (HELSTF), where weapons-grade lasers reside, demonstrated the first passively controlled vertical free flight of an object that was propelled by the U.S. Army's 10 kW Pulsed Laser Vulnerability Test System (PLVTS) infrared CO<sub>2</sub> laser. The PLVTS laser was built by AVCO TEXTRON and is the highest average power, pulsed CO<sub>2</sub> laser presently operating in the United States. Laser boost capability was demonstrated at the HELSTF with a lightcraft reaching 4.3 meters vertically in 2-second gyroscopically stabilized free flights, which was followed by horizontal guide-wire flights of 121.9 meters lasting 10 to 20 seconds. A subsequent series of test flights achieved an altitude of 38.7 meters. See Figures 13 – 15.

This achievement can be compared to the first successful flights of Robert Goddard's liquid propellant chemical rocket, which attained a height of 12.5 meters after a 2.5 second burn in March 1926. In sharp contrast with Goddard's rockets, there is absolutely no fuel on board the prototype lightcraft, which has a diameter of 15 cm, mass of 40 – 60 grams, and is machined from a solid block of 6061-T6 aluminum. Five different lightcraft designs have been flight-tested using the pointing and tracking system on the

PLVTS laser, which is run by Stephen Squires and Chris Beairsto of WSMR's Directorate of Applied Technology Test and Simulation. Current lightcraft designs are limited to about 60 grams mass and 15 cm in diameter by the PLVTS laser (see Figure 16). The PLVTS laser also limits flight altitudes to  $\approx 40$  meters because of the beam power and divergence of the beam.

The near-term experimental goal is to reach an altitude of 1 km with the PLVTS laser. To climb to 10 – 100 km or near the edge of space will require re-activation of the 150 kW pulsed "Driver" infrared CO<sub>2</sub> laser, now stored in Test Cell #2 at HELSTF. Preparations are underway to utilize this laser, which was developed at the AVCO Research Laboratory (Everett, MA) in the mid-1970's under the guidance of Dr. Arthur Kantrowitz, a long time advocate of laser propulsion. A MW-class laser will be necessary for a kilo-class lightcraft to reach orbit. Components for high-powered research lasers exist that are capable of launching a kilo-class lightcraft to orbit, which would demonstrate the feasibility of this technology for low cost access to space.

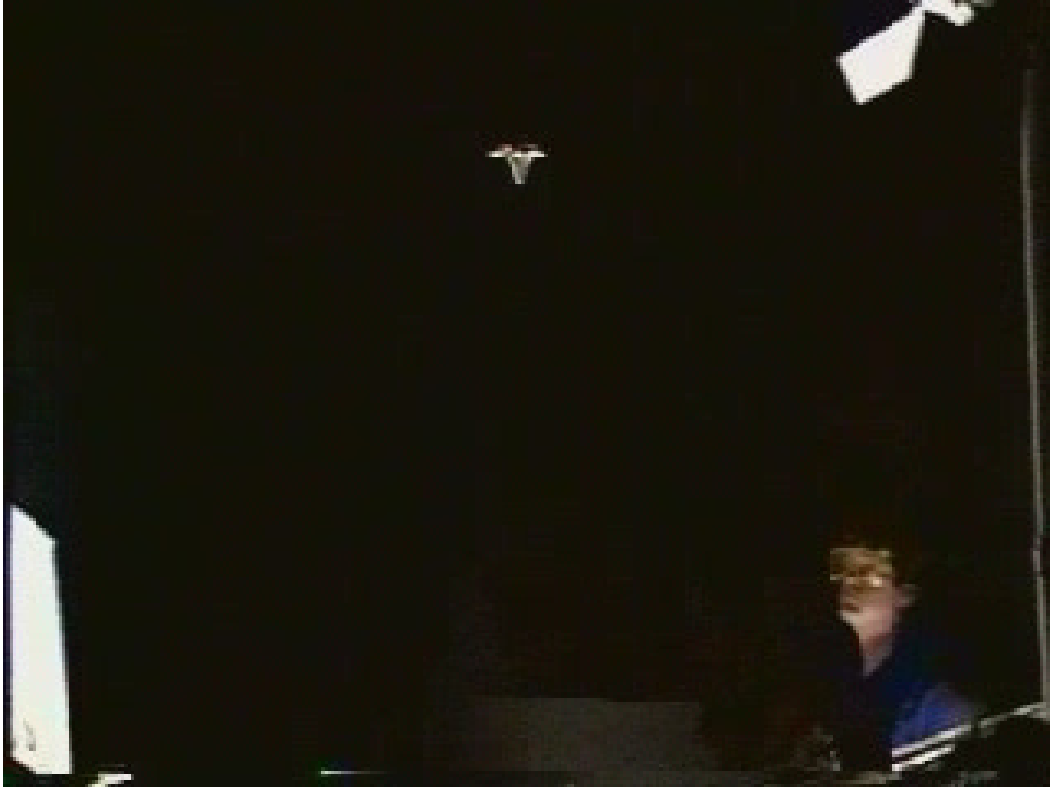


**Figure 13. Lightcraft Undergoing Horizontal Guide-Wire Flight Test  
(from [www.Space.com](http://www.Space.com))**





**Figure 14. Time-Lapse Photo Of A Lightcraft Undergoing An Outdoor Vertical Flight Test  
(From AFRL Press Release)**



**Figure 15. Lightcraft Undergoing Indoor Vertical Flight Test (from [www.Space.com](http://www.Space.com))**



**Figure 16. Several Lightcraft Flight-Test Vehicles (from [www.Space.com](http://www.Space.com))**

### 3.3.3 Summary of Technical Performance and Benefits

We outline below the salient features of the RF-powered lenticular craft and lightcraft launch systems (Bekey, 2003):

- Both systems are SSTO and completely reusable
- Almost no on-board propellant is required (the reaction mass is free air), except for the small internal amount of propellant needed for final ascent to orbit and orbital maneuvering
- Vehicle  $I_{sp}$  is essentially infinite ( $\approx several \times 10^3$  seconds in rocket mode)
- Payload mass fractions are  $\approx 50 - 95\%$
- These systems are simple, reliable, safe, environmentally clean, and could have a very high all azimuth on-demand launch rate
- Reduces space launch costs by two to three orders of magnitude below today's levels
  - Estimated launch costs: \$20 – 200/kg of payload
- The feasibility and physics principles for both beamed-power propulsion systems has been proven by the AFRL's Lightcraft Concept Demonstration Program (Myrabo et al., 1989; Myrabo et al., 1998; Mead et al., 1998; Wang et al., 2000, 2001, 2002; Messitt et al., 2000; Myrabo, 2001; Mead and Larson, 2001; Larson et al., 2002; Mead et al., 2002; Froning, 2003; Froning et al., 2003)
- This is a class of vehicles that will create an industrial revolution in space

The RF-powered lenticular craft and lightcraft systems have sufficient power density to operate as Earth-to-orbit (ETO) launch systems. They both require a beam power of  $\sim 0.1$  MW per kg of vehicle mass, while in-space orbit-to-orbit propulsion requires a modest 0.1 – 10 MW of total beam power. The ground-based GW-class RF beam and MW-class laser beam generators are state-of-the-art technology. The cost of generating electrical power for the ground-based RF or laser beam generator/transmitter is  $\sim \$0.10/\text{kWh}$ , which translates to  $< \$2/\text{kg}$  of payload. An SDIO study (Myrabo, 1986; Kare, 1987; Myrabo et al., 1989) showed that all launch to orbit conditions for a lightcraft could be satisfied by a single, high-power ground-based laser – with or without the aid of a low altitude laser relay mirror or space-based laser beam generator system. The SDIO study results are applicable to the RF-powered lenticular craft. The majority of the system mass required to launch a 1-ton payload to orbit is left on the ground in the form of the beam generators and their electrical power sources. The dry spacecraft mass can be reduced by two orders of magnitude, and thus the operating costs reduced by a factor of 10 (to  $\approx \$2/\text{kg}$  of payload), if Buckytubes are used to construct the vehicle and its subsystems.

This advanced propulsion concept was formerly categorized as mid/far-term because it involves a degree of technology development or risk reduction. However, ongoing experimental research and test flight demonstrations continue to mature the state-of-the-art to the point where beamed-power propulsion has become a near-term technology. It has such far-reaching capabilities that it represents a new and vital way of realizing the benefits of space.

### 3.4 Nuclear Propulsion: Fission and Fusion Rockets

This is the class of nuclear powered propulsion systems. The two versions of this concept use nuclear fusion or fission to heat and expand liquid/gas/plasma (low molecular weight) propellants, or to generate electrical power, in order to generate thrust. There are numerous excellent nuclear propulsion schemes in the literature, which comprises 50 years of R&D work (McLafferty, 1970; Gabriel et al., 1970; Hsieh, 1975; Howe, 1985; Bohl and Boudreau, 1987; Haloulakos, 1988; Miller, 1990; Dearien, 1990; Bennett and Miller, 1991; Borowski, 1991; Walton, 1991; ISNPS, 2003). Most nuclear propulsion schemes were specifically designed for propulsion in space; however, there were very early designs for launch vehicle or aerospace vehicle applications.

The energies (per unit mass) available from nuclear reactions, such as fission, fusion or matter-antimatter annihilation, ranges from  $10^7$  –  $10^9$  times that of chemical reactions. This results in the achievement of tremendous increases in rocket specific impulse. But there are many practical difficulties in converting nuclear reaction energy into exhausted propellant energy. Some nuclear propulsion designs have much lower conversion efficiencies than chemical rockets. For fission propulsion this is due to the low fraction of nuclear fuel burn-up in the reactors and the losses encountered when transferring fission thermal energy to the propellant. For fusion propulsion this is due to the extremely low power-to-weight ratio of the reactors, neutron-induced radioactivity generated by heavy hydrogen fuels, strong radiation emission from the thermalized ion-electron distribution, and plasma confinement problems. However, many of these problems have been mitigated, reduced or eliminated by novel design improvements. But ultimately, nuclear propulsion still outperforms chemical rockets.

The author chose two outstanding concepts that employ novel engineering-physics approaches for the conversion of nuclear energy to propulsive thrust. The first propulsion concept is based on a novel application of nuclear fusion, and the other is based on a recently developed advanced nuclear fission reactor concept that involves novel technical improvements. The reader should note that nuclear fusion space propulsion was originally, and traditionally, not designed for launch vehicle applications (Hsieh, 1975; Miley, 1987, 1988; Borowski, 1988; Schulze, 1991). However, the novel fusion propulsion concept the author selected for the present study was developed just for that purpose.

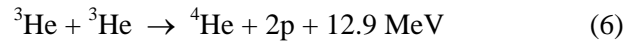
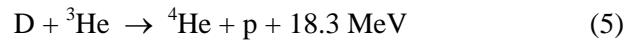
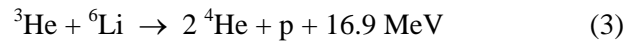
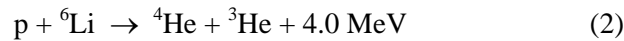
#### 3.4.1 QED/ARC IEF Reusable SSTO or Starfighter

This is a propulsion concept that is based on a form of nuclear fusion. There are numerous schemes and devices that have been built and tested to explore the production and extraction of fusion energy for commercial electrical and space propulsion and power applications. None of the space propulsion designs have any relevance to launch vehicle applications. Fusion plasma confinement approaches for space propulsion or power applications include the field-reversed configuration, tandem mirror, spherical tokamak, inertial confinement fusion, dense plasma focus, and magnetically insulated inertial confinement fusion. These approaches reduce or practically eliminate the confounding plasma confinement problem that has plagued fusion reactor physics for years. However, all of these approaches still suffer from extremely low reactor power-to-weight ratios due to bulky magnetic components, heavy high-power compression and catalyst drivers, and other massive structural components (i.e., radioactive shielding). These reactors use heavy hydrogen fuels (in neutron-producing reactions involving Deuterium and/or Tritium) and they appear only marginally able to burn the “advanced” fuels (in aneutronic reactions involving protons, Boron, Helium, Deuterium, and Lithium). That is because of the strong radiation emission (i.e., undesirable highly efficient plasma cooling) from the thermalized (Maxwellian) ion-electron energy distribution in the plasma. The desirable advanced fuel fusion reactions yield only charged particle products, such that they produce no radiation hazards from the energetic neutrons that are always produced by reactions using Deuterium fuel mixtures.

A novel new fusion confinement concept, called the Quiet-Electric-Discharge (QED) Inertial Electrostatic Confinement Fusion (IEC or IEF), was developed for the purpose of realizing a high performance fusion rocket engine that simultaneously possesses high thrust-to-mass (or thrust-to-weight)

ratios and high specific impulse compared to that of chemical and nuclear fission rockets. This novel fusion propulsion technology is quite capable of supporting the full scope of aerospace (i.e., hypersonic flight) and launch vehicle applications. The particular QED-IEF propulsion concept that the author chose for this study is called the Quiet-Electric-Discharge/All-Regeneratively-Cooled IEF (or QED/ARC IEF) direct electrical conversion system. There are other interesting versions of the QED-IEF power and propulsion concept, but they apply to deep space missions, which is beyond the scope of the present study.

An IEC fusion power source can attain a very high power-to-weight ratio because it does not require heavy magnetic components, high-power drivers, and the other massive structural (radioactive shielding) components normally required by conventional fusion propulsion and power devices. An additional, but very important, feature of IEC devices is that they possess an excellent efficiency for burning advanced fuels as a result of the highly non-Maxwellian energy distribution attained by the reacting ions. The advanced fuel (aneutronic) fusion reactions are (Huba, 1994):



It should be noted that reactions (1) and (2) are actually thermonuclear fission reactions (Hsieh, 1975). All of the above reactions are superclean with respect to radioactivity, such that the relative radioactivity present in the reaction system is  $\sim 0$ . Therefore, no bulky-massive shielding structure is required for any fusion power and/or propulsion applications that are fueled by reactions (1) – (6), because the weight (or mass) penalty from radiation shielding would no longer exist. Last, these reactions are very suitable for direct energy conversion without the need for an intermediate energy conversion medium. The charged particle reaction products can be captured by external magnetic and/or electric fields and directly converted to electrical power, or used to directly heat and expand a propellant, which will be described in the following.

The IEC/IEF concept was originally pioneered by Farnsworth (1956) and became largely dormant for over two decades, but it was later revived and revised by Bussard and coworkers (Bussard, 1989, 1990, 1991, 1992, 1993, 1997; Krall, 1992; Bussard and Jameson, 1993, 1994, 1995; Bussard et al., 1993; Froning and Bussard, 1993, 1998; Froning, 1997; Bussard and Froning, 1998; Watrus et al., 1998; Froning et al., 2001) and Miley and coworkers (Nadler et al., 1992; Miley et al., 1993; Barnes and Nebel, 1993; Miley et al., 1994; Satsangi et al., 1994; Miley et al., 1995; Nadler et al., 2000). It is also of historical interest to note that P. T. Farnsworth is the inventor of television (Everson, 1949). Bussard and Miley and their coworkers discovered a way to configure the IEC device for electric power and space propulsion applications using modern engineering-physics and materials technology.

The IEC fusion device is a spherical vacuum vessel (pumped to  $< 10^{-6}$  Torr) that uses quasi-spherical polyhedral magnetic fields to confine electrons, which are injected into the vessel at high energy, in order to form a negative electric potential well that confines fusion ions in a spherically-converging flow. Energetic fusion ions are generated by a plasma discharge and then injected into the potential well near its boundary, where they are accelerated radially inward towards the center and oscillate across the vessel with the central core plasma density increasing rapidly as  $r^{-2}$  (towards the center). As the ions converge

at the center of the vessel, they form a dense central plasma core region where fusion occurs, resulting in an extremely high fusion power density (see Figures 17 and 18). The ions reach maximum density at a core radius set by the ratio of their initial transverse energy at injection, to their energy at the core boundary (radius  $r_c$ ). Bussard and Jameson (1995) report that typical ion convergence ratios are  $0.001 < \langle r_c \rangle < 0.01$  ( $\langle r_c \rangle$  = averaged core boundary radius), thus yielding a core densification of  $10^4 - 10^6$  times above the minimum ion densities (near the edge of the polyhedral magnetic surface) in the system. Any unburned fuel is recycled through the vacuum system.

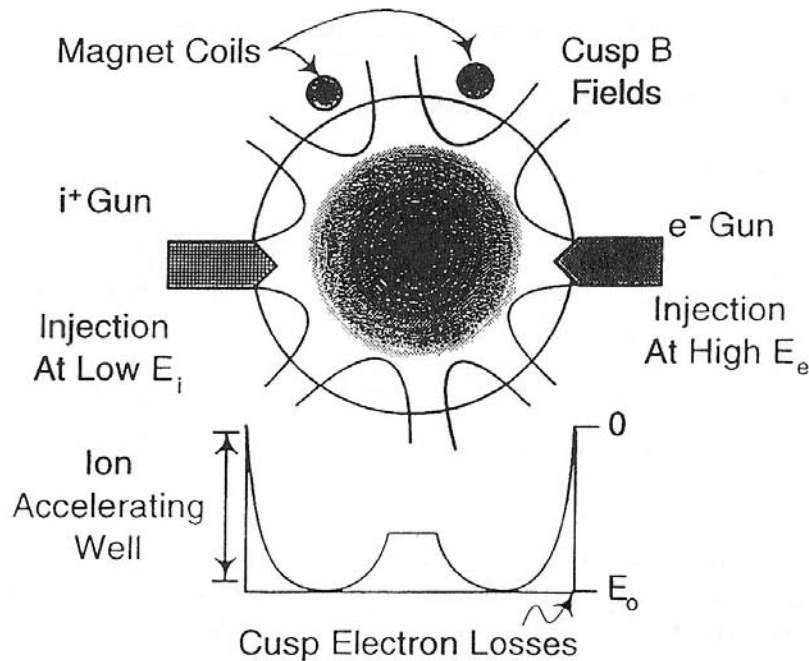
Direct production of high-voltage electrical power is by the deceleration of charged fusion product ions in an externally imposed electric field. The product ions escape from the central plasma core predominantly along radial (micro-channel) paths and can be collected, as they approach zero kinetic energy, by potential-biased grids placed at appropriate radial positions along their path (see Bussard and Froning, 1998 for technical details). The grid collectors are connected to the electrical circuit driving current through the system external load (see Figure 19). The output power generated by this process will appear as modest DC currents (kA) at high voltages (typically 0.5 – 2.24 MV). The feasibility of this direct conversion scheme has been proven by previous experimental research (Moir and Barr, 1973; Barr and Moir, 1983). Bussard and Froning (1998) report that the direct conversion process is nearly 100% efficient. And Miley et al. (1995) describe experiments which show that the fraction of ions intercepting the collector grid wires is greatly reduced by using a particular grid geometry that has a 97% effective transparency to the radial micro-channel ion flows, thereby greatly improving grid wire lifetime and performance.

Bussard discovered that the easiest fusion products to direct-convert are those of reaction (1) because the  $^4\text{He}$  particles (a.k.a.  $\alpha$ -particles) have well defined discrete energies ( $2\alpha$ 's  $\times$  2.46 MeV and  $1\alpha$   $\times$  3.76 MeV). The electric field deceleration requires a retarding potential of  $\approx$  1.9 MeV since the  $\alpha$ -particle charge is  $Z = 2$ . Spherically symmetric grids located 0.5 – 1 m outside of the IEC ion-confining region supply the retarding potential. Therefore, IEC systems only need to be 1 – 2 m larger in diameter than the size required for producing the controlled fusion process. Bussard noted that reactions (3), (5), and (6) are marginally suitable for direct electrical power production in the present scheme, because the energy distribution of the reaction products is continuous rather than discrete, such that the proton energies can vary from zero to a maximum value while the  $\alpha$ -particle energies will vary over a finite range. To convert this spread of ion energies (including the maximum proton energy) will require the use of numerous additional collection grids or plates, which will increase the system's overall radial dimensions to  $\approx$  5 – 10 m. This will pose severe thermal and mechanical problems worse than those for reaction (1).

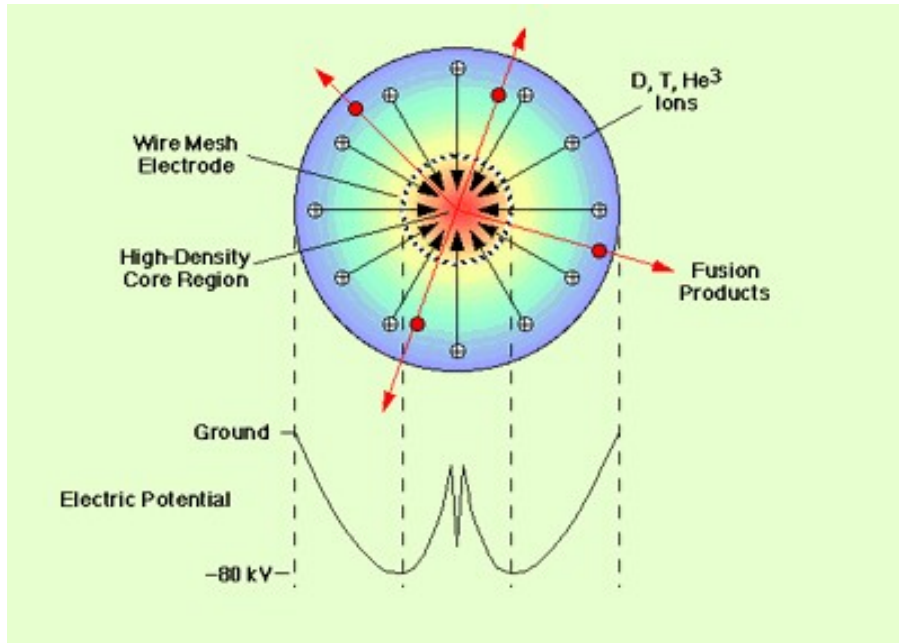
However, Bussard further noted that reactions (3), (5), and (6) appear to be very suitable for deep space propulsion applications via an IEC direct propellant heating device, which is beyond the scope of the present study. Miley et al. (1995) propose an IEC direct conversion propulsion system that runs on reaction (5) and operates in a pulsed-power mode as an efficient way to decrease the collector grid heating. Pulsed-power operation also has the advantage that the high peak currents result in a high fusion energy gain for the IEC device, due to highly nonlinear scaling of the fusion rate with ion current. Their lab experiments use a prototype IEC device that has been in operation at the University of Illinois Fusion Studies Laboratory (see Figure 20). There has been no research literature to date describing IEC propulsion and/or power applications using reactions (2) and (4). Reactions (3), (5) and (6) are going to be very difficult to implement, because  $^3\text{He}$  is extremely scarce on Earth (natural abundance is  $1.38 \times 10^{-6}$ ) to obtain a sufficient quantity to fuel fusion power and propulsion applications, but it is largely available in the Lunar regolith which is believed to contain  $\sim$  1 million tons of  $^3\text{He}$ .

The IEC output electrical power is then used (with little power conditioning) to drive sub-relativistic electron beams (SREB) that are used to heat and expand propellant in a thrust chamber, as well as to power the IEC device itself. The SREB are injected into a rotational-flow rocket (cylindrical) thrust chamber, where the beam energy is deposited directly into a rotationally confined high-pressure propellant, on the axis of the thrust chamber (of 0.5 m length for stable SREB-propellant coupling). The SREB heats the propellant to very high gas/plasma temperatures, thus forming a dense plasma core along

the thrust chamber axis. Thermal radiation from the plasma core is absorbed by the radially inflowing fluid/gas/plasma, which then flows longitudinally along the system axis to a magnetically insulated converging-diverging exhaust nozzle to generate thrust (see Figure 21). The thrust chamber and exhaust nozzle walls are insulated from the plasma by axial magnetic fields (0.2 – 1.0 Tesla) that can reduce gas/wall heat transfer by two orders of magnitude from conventional convective processes. The axial magnetic fields also stabilize the propagating SREB. The magnetic coils generating the axial insulation fields can be located outside the thrust chamber/exhaust nozzle structure and cooled cryogenically by liquid hydrogen. The propellants that can be used are water, hydrogen, ammonia, methane, and other low molecular weight fluids. The propellant chosen for this study is hydrogen. The thrust chamber operating pressure must be optimized for energy deposition profiles to match propellant flow in order to obtain the optimum  $I_{sp}$  at the desired net thrust generated by the system. Maximum  $I_{sp}$  will be obtained at pressures that promote some recombination of the dissociated and ionized gas species in the nozzle exhaust flow.



**Figure 17. The IEC Concept: Ion Acceleration By Electron-Injection-Driven Negative Potential Well Maintained In Polyhedral Magnetic Field (Bussard And Jameson, 1995)**

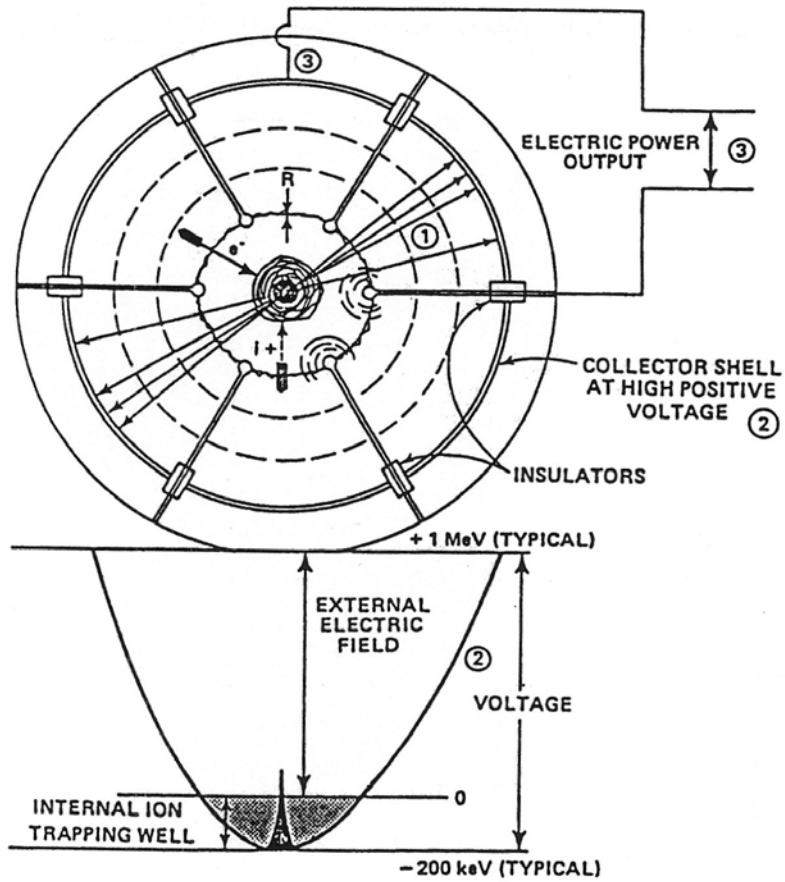


**Figure 18. The IEC Fusion Direct Energy Converter Device: Fusion Reaction Ions Are Acceleration By Electron-Injection-Driven Negative Potential Well Maintained In Polyhedral Magnetic Field**

(from [www.islandone.org/APC](http://www.islandone.org/APC)).

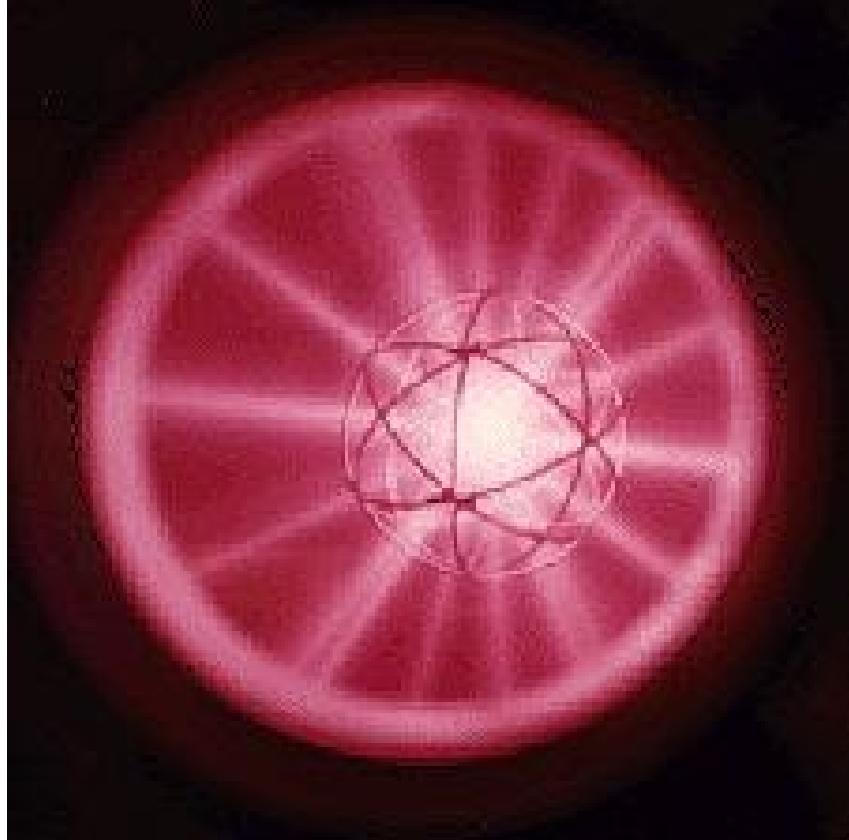
The product ions escape against a spherically symmetric radial voltage gradient and yield radiation-free direct electrical power output. The 80 kV well depth is only an illustrative example since a 180 kV well depth is typical for the QED/ARC IEC fusion propulsion system that runs on the  $p\text{-}^{11}\text{B}$  fusion reaction.





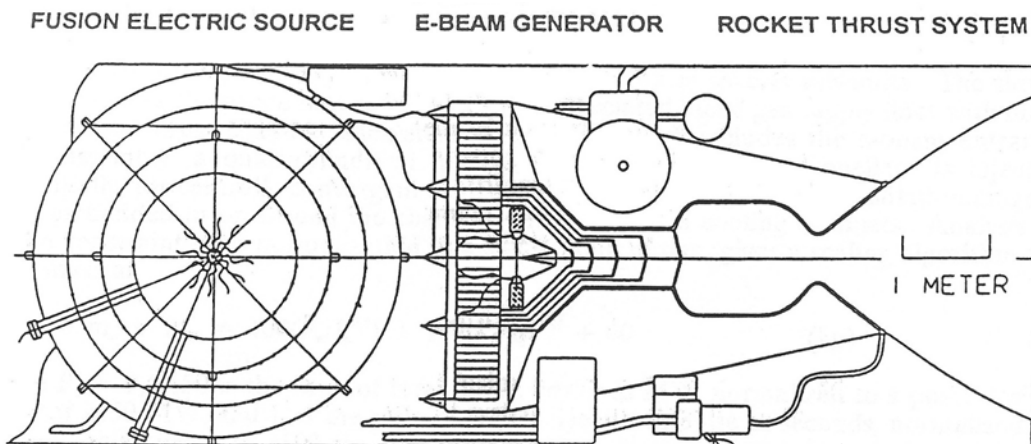
**Figure 19. IEC Fusion Direct Energy Converter Device**

Fusion reaction products are energetic ions (1), which escape against spherically symmetric radial voltage gradient (2); to yield radiation-free direct electrical power output (3) (Bussard, 1993).



**Figure 20. Experimental IEC Device Operating In The “Star Mode”  
At The University Of Illinois Fusion Studies Laboratory (Miley et al., 1995)**

Note the geometrical arrangement of the grid collectors, and the radial (outgoing) ion micro-channel flows. The contained fusion plasma core is the bright blob at the center of the device.



**Figure 21. Schematic Of A Complete QED/ARC IEC Rocket Engine System**  
Showing basic components, structure, layout, and subsystems; fusion-electric power source, sub-relativistic electron beam generator; thrust system (Bussard, 1993).

We outline below the important performance parameters of the propulsion system, which were derived for a fully reusable SSTO launch vehicle or future Air Force Starfighter (Bussard, 1993; Bussard and Jameson, 1995; Froning and Bussard, 1998):

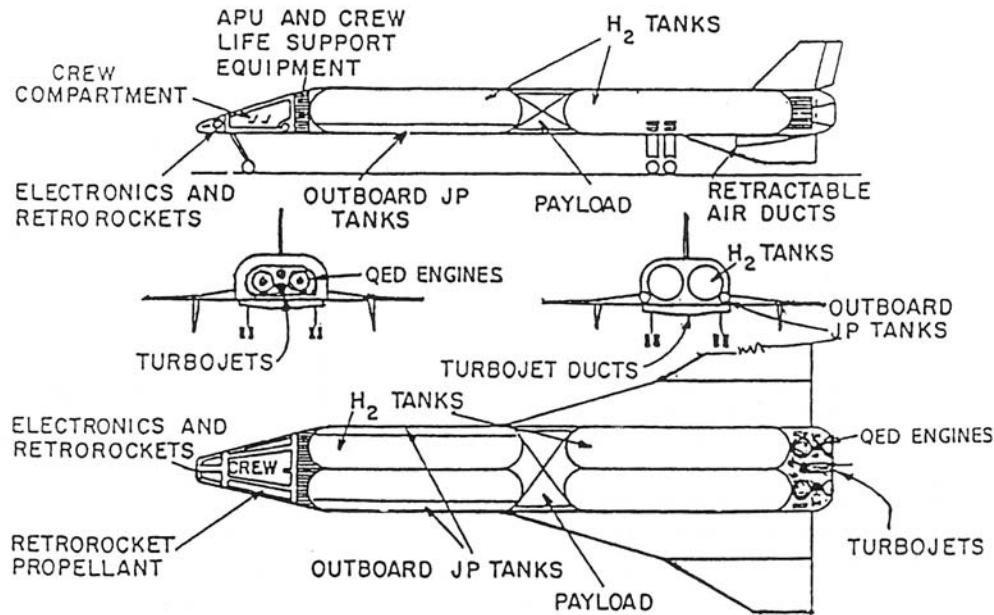
- Reusable SSTO or Starfighter QED/ARC IEC propulsion system optimized for high  $I_{sp}$  and high Thrust-to-Mass ratio ( $F$ )
- $1,500 \leq I_{sp} \leq 5,500$  seconds
- $6 \geq F \geq 2$
- $700 \text{ kN} \leq \text{Thrust} \leq 33 \text{ kN}$
- the  $v_{\text{flight}}$ -averaged (in vehicle drag environment over the flight path to orbit) net effective  $I_{sp} \approx 2,200 - 2,500$  seconds (which varies with  $v_{\text{flight}}$ )
- 1 – QED/ARC IEC propulsion engine produces 2,650 MWt thrust power output

Bussard (1993), Bussard and Jameson (1995), and Froning and Bussard (1998) provide the following example case study for their reusable QED/ARC IEC SSTO launch vehicle design, which the author adopted for the present study as a recommended advanced propulsion concept vehicle configuration with corresponding payload launch-to-orbit performance (see Figure 22):

- ❑ Reusable SSTO winged vehicle: 250,000 kg GTOW
- ❑ Vehicle is driven to orbit along a specified fly-out trajectory using turbojet propulsion to Mach 2.5, and then operates under rocket propulsion by 2 – QED/ARC IEC engines (5,300 MWt total thrust power output) thereafter
- ❑ 62% GTOW can be carried to LEO @ 555 km altitude in equatorial eastward launch
- ❑ Dry vehicle mass fraction is 48%, thus giving a payload fraction of 14%, or a payload mass of 35,000 kg to orbit on each flight
- ❑ Launch cost estimate: \$51/kg of payload, if commercially developed and operated
- ❑ Launch cost estimate: \$27/kg of payload, if developed and operated by the U.S. government
- ❑ QED/ARC IEC SSTO vehicle provides 20 times greater payload delivery per unit mass of vehicle than the Space Shuttle

The QED/ARC IEC propulsion system has undergone extensive modeling and experimental validation over the past 20 years. Bussard originally received theoretical and experimental support from DARPA in 1984 – 87 and 1989 – 92, with additional support provided by the SDIO through the Defense Nuclear Agency in 1987 – 88 (Bussard, 1993). Bussard received additional R&D support later on from the U.S. Navy, the Electric Power Research Institute, and the Department of Energy Basic Energy Sciences Division through the Los Alamos National Laboratory. This advanced propulsion concept was formerly categorized as mid/far-term because it involves a degree of technology development or risk reduction. However, ongoing experimental research continues to mature the state-of-the-art to the point where this concept has become a near-term technology. It has such far-reaching capabilities that it represents a new

and vital way of realizing the benefits of space. Further R&D work is required to continue maturing the QED-IEC technology development, but funding has been inadequate or not available on a consistent basis in recent years for reasons involving politics, agenda, legacy, or simple resistance to different ways of doing things. Experimental research on a pulsed-power IEC device has shown promising results indicating a very high fusion energy gain. R&D funding is needed to scale both the steady-state and pulsed-power IEC devices up to full-sized rocket engine testing and validation. This advanced propulsion concept can be implemented within 10 years to meet all manned and unmanned space mission requirements.



**Figure 22. QED/ARC IEC SSTO Reusable Winged Launch Vehicle or Future Air Force Starfighter** (Bussard, 1993; Bussard and Jameson, 1995).

### 3.4.2 Nuclear DC-X

The energy available from a unit mass of fissionable material is  $\sim 10^7$  times larger than that available from the most energetic chemical reactions. That is because nuclear fission has an energy density of  $8 \times 10^{13}$  J/kg compared to chemical reactions with an energy density of  $10^7$  J/kg. Therefore, nuclear fission is very attractive for propulsion. The general operating principles for nuclear thermal rocket (NTR) propulsion are similar to those of conventional chemical rocket propulsion. A propellant is heated in the rocket chamber, thereby raising its stagnation enthalpy, and exhausted through a converging-diverging nozzle to achieve supersonic exit flow (Hill and Peterson, 1970). The reactor core is designed to efficiently transfer heat from the fission reactor core to the propellant while minimizing system mass. The reactor core uses U-235 in some particular fuel form (i.e., rods, particles, thin-film, fluid, plasma, etc.). The propellant is usually LH<sub>2</sub>, which is also used to cool the reactor. LH<sub>2</sub> is a low molecular weight propellant, which therefore allows the NTR to achieve very high  $I_{sp}$  values. Only one propellant is necessary in a NTR because there are no chemical combustion processes involved. An expander cycle drives the turbopumps, and control drums located on the periphery of the core control the reactivity of the reactor. Material constraints are a limiting factor in the performance of solid core nuclear rocket engines. The maximum operating temperature of the propellant must be less than the melting point of the fuel,

moderator, and core structural materials. This corresponds to specific impulses of 800 – 900 seconds with thrust-to-weight ratios greater than one.

Solid-core nuclear rocket R&D took place in the U.S. prior to 1973, and \$1.4 billion dollars was invested in the program. Over 20 NTR reactors were designed, built and “open air” tested at the Nevada Nuclear Test Site-Nuclear Rocket Development Station at Jackass Flats, Nevada. This program concentrated on the development of large, high-thrust engines, and was to support the manned Mars mission. A series of engines based on hydrogen-cooled reactor technology was built and tested during the 1950’s – 70’s. These were the ROVER program test engines (Walton, 1991; Cinnamon, 1992; ISNPS, 2003): KIWI-A (1958 – 60; 100 MWt, 0 kN thrust), KIWI-B (1961 – 64; 1,000 MWt, 222.4 kN, thrust), KIWI-TNT, Phoebus-1 (1965 – 66; 1,000 & 1,500 MWt, 222.4 kN thrust), and Phoebus-2 (1967; 5,000 MWt, 1,112.1 kN thrust). These test engines achieved H<sub>2</sub> (hydrogen propellant) exhaust temperatures of 2,350 – 2,550 K (using graphite fuel), an I<sub>sp</sub> of 825 – 850 seconds, burn durations from 62 minutes to greater than 4 hours, and an engine thrust-to-weight of ~ 3.

There were other test reactor engines called PEWEE-1 (tested in 1968) and Nuclear Furnace-1 & 2 (tested in 1972). The ROVER program originally began in 1953 with two main study programs called KIWI and TORY. KIWI was the main NTR development program managed by LANL, and TORY was the nuclear ramjet development program (a.k.a. Project PLUTO) which was managed by Lawrence Livermore National Laboratory (LLNL). The cores of these reactors consisted of clusters of fuel elements through which the hydrogen coolant was passed. Fissionable material in the graphite fuel element was in the form of particles of uranium carbide coated with pyrolytic carbon. Flow passages in the fuel elements were coated with niobium to protect the graphite from the corrosive effect of hydrogen propellant.

The flight-rated graphite engine that was developed as a result of the ROVER program was called NERVA (Nuclear Engine for Rocket Vehicle Applications), and the two test reactor series were called XE-Prime (tested in 1969) and NRX (tested in 1964 – 67) (Borowski, 1990; Cinnamon, 1992; ISNPS, 2003). The NERVA-1 NTR engine was designed circa 1972 – 73, but it was never built. The NERVA engine was designed to operate at 1,500 MWt, provide 333 kN of thrust at a I<sub>sp</sub> of 825 seconds, and have an engine weight of 10.4 metric tons. It was engineered for a ten-hour life and sixty operating cycles. The NERVA engine development program was very near completion when it was terminated in 1972. The ROVER and NERVA programs were a technical success. The next step would have involved a flight demonstration in Earth orbit. Since that time, there has been some limited work on fuels and materials. And several NERVA-derivative engines have been proposed, which would employ modern materials, turbopumps, and turbopump cycles to take NERVA performance to I<sub>sp</sub> ≥ 900 seconds.

Los Alamos National Laboratory (LANL) and Aerojet also designed a Small Nuclear Rocket Engine (SNRE) for unmanned mission and Space Shuttle upper stage applications (Cinnamon, 1992; Piltch, 2000). The SNRE featured a split-nozzle design that swung to the side for storage to conserve Shuttle cargo bay volume. This was a 370 MWt engine with 72.6 kN of thrust. Two engine designs, both weighing 2.6 metric tons, were proposed. The first design operated at a I<sub>sp</sub> of 875 seconds, and the second was an advanced design that operated at a I<sub>sp</sub> of 976 seconds (Cinnamon, 1992; Piltch, 2000). The SNRE was engineered for a two-hour life and twenty operating cycles. The reactor used a zirconium-hydride moderator to provide the necessary neutronic reactivity in the small core and a high-performance composite (UC-ZrC-C) fuel element.

Solid-core NTR propulsion represents a relatively mature advanced propulsion technology. Current NERVA-type NTR technology requires the use of chemically reducing propellants (such as hydrogen, ammonia, etc.). Strongly oxidizing propellants like LO<sub>x</sub> cannot be used because they would attack the nuclear fuel and engine materials. The LO<sub>x</sub>-Augmented Nuclear Thermal Rocket (LANTR) concept is a recent novel NTR design modification that uses oxygen propellant. The LANTR concept was originated by Borowski et al. (1994, 1995), and it involves the use of a conventional H<sub>2</sub> propellant NTR with LO<sub>x</sub> (a.k.a. O<sub>2</sub>) injected into the exhaust nozzle. Cascade scramjet injectors introduce oxygen into the supersonic nozzle, whereby the injected oxygen acts like an afterburner and operates in a reverse scramjet mode (see Figure 23). Supersonic combustion of oxygen in the nozzle substantially increases the thrust-

to-mass (or thrust-to-weight) ratio of a conventional NTR. This makes it possible to augment and vary the thrust at the expense of reduced  $I_{sp}$ . The performance chart in Figure 23 shows that a LANTR engine operating with an oxidizer-to-fuel ratio of 3 has higher thrust and jet power at lower  $I_{sp}$  compared to the pure  $H_2$  NTR. From the chart one can see that a LANTR engine still outperforms even the best conventional chemical rockets, which achieve an  $I_{sp} \leq 450$  seconds for comparable thrust and jet power.

The cost of ground-test facilities for NTR testing scale with engine thrust, because of the need to scrub the engine exhaust of any nuclear materials. The LANTR concept can enable low-cost testing of a small NTR engine capable of producing high thrust in the LANTR mode. The LANTR mode could be tested in a non-nuclear facility separately from the NTR engine by using resistively heated (i.e., non-nuclear heated)  $H_2$ . The Aerojet Corp. completed non-nuclear demonstration tests of the LANTR concept in 2002 (Hrbud, 2002). The Aerojet tests used a highly fuel-rich conventional  $H_2/O_2$  rocket to simulate the hot  $H_2$  exhaust of an NTR, while their cascade scramjet injectors introduced  $O_2$  into the supersonic nozzle. The tests showed a thrust increase of 53% and an  $O_2$  combustion efficiency of 73%. Elevated nozzle pressures were measured, benign nozzle wall environment was observed, and increased  $O_2$  consumption rate with nozzle length was measured during the tests (ISNPS, 2003). Aerojet plans to run hot, dry  $H_2$  tests of the LANTR concept, and anticipate a thrust augmentation from the current 30% up to 100%.

Summary of LANTR performance improvements over conventional NTR's (ISNPS, 2003):

- LANTR couples a reverse scramjet  $LO_x$ -afterburner nozzle to a conventional  $LH_2$ -cooled NTR to achieve the following benefits:
  - LANTR engines are smaller, cheaper NTR's with "big engine" performance
  - Smaller, cheaper facilities for contained ground testing
  - Variable thrust and  $I_{sp}$  capability from constant power NTR
  - Shortened burn times and extended engine life
  - Reduced  $LH_2$  propellant tank size, mass, and boil-off
  - Reduced stage size allowing smaller launch vehicles
  - Increased operational range – ability to utilize extraterrestrial sources of  $O_2$  and  $H_2$

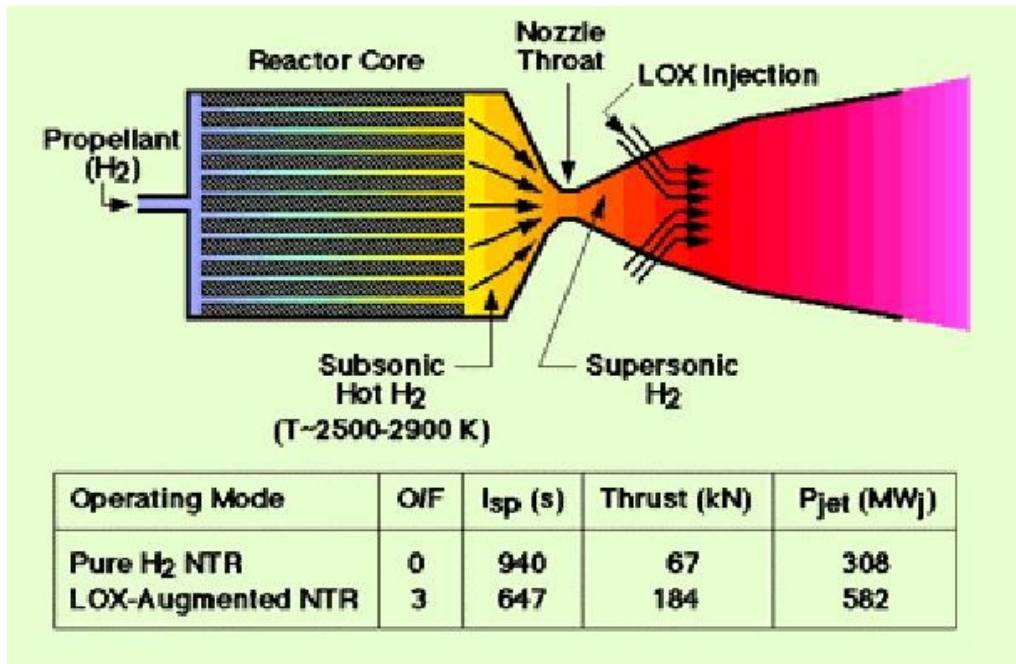


Figure 23. Schematic Of The LANTR Concept (from [www.islandone.org/APC](http://www.islandone.org/APC))

March (2001) adapted the LANTR engine concept to a fully reusable VTOL-SSTO launch vehicle that he designed. The author chose the LANTR VTOL-SSTO design as a recommended advanced propulsion concept because of its novel application of the LANTR concept to NTR propulsion, which dramatically improves launch vehicle performance and operating costs over the full range of the flight envelope to orbit. The vehicle is designed to fly and operate like the DC-X (Section 1.2), therefore the author proposes to rename March's concept the "Nuclear DC-X." March proposes that the Nuclear DC-X LANTR engine can operate using either of two different nuclear reactor designs:

□ Nuclear DC-X comes in two "nuclear flavors":

1. Pellet Bed Reactor (PeBR) NTR

a) Performance in pure NTR mode:

- $I_{sp} \approx 1,000$  seconds
- Thrust = 1,112 kN/engine
- Thrust/Weight > 12
- $v_{ex}$  (exhaust velocity) = 9.8 km/sec

b) Performance in LANTR mode:

- $I_{sp} \approx 600$  seconds
- Thrust = 3,336 kN/engine

- Thrust/Weight > 38
- $v_{ex} = 5.9$  km/sec

## 2. Thin-Film Fission Fragment Heated NTR

- A high-performance NTR formulated by C. Rubbia
- Reactor core consists of thin-walled porous propellant flow passages coated with a thin layer of Americium-242m
- Propellant is injected radially into the flow passages and heated directly by fission fragments from the Am-242m liner
- This approach allow for much higher bulk temperatures in the propellant than in a conventional NTR while keeping the propellant in contact with the walls (within the material temperature limits)
- Theoretical  $I_{sp} = 2,000 - 4,000$  seconds
- Thrust is comparable to a conventional NTR
- Fission Fragment LANTR mode performance is comparable to the PeBR LANTR mode performance

The PeBR NTR in item 1 above has nuclear fuel that is in the form of a particulate bed (fluidized-bed, dust-bed, or rotating-bed) through which the propellant is pumped (El-Genk et al., 1990; Ludewig, 1990; Horman et al., 1991; ISNPS, 2003). This permits NTR operation at a higher temperature than solid-core NTR's by reducing the fuel strength requirements. This results in the increased engine performance noted above. The core of the reactor is rotated about its longitudinal axis at approximately 3,000 rpm so that the fuel bed is centrifuged against the inner surface of a cylindrical wall through which  $H_2$  gas is injected. This rotating bed reactor has the advantage that the radioactive particle core can be dumped at the end of an operational cycle and recharged prior to a subsequent burn, thus eliminating the need for decay heat removal, minimizing shielding requirements, and simplifying maintenance and refurbishment operations.

Thin-film fission fragment propulsion involves allowing the energetic fragments produced in the nuclear fission process to directly escape the reactor. Thus, the fission fragments, moving at several percent of the speed of light, can be directly used as the propellant (Chapline, 1988; Wright, 1990; Ronen et al., 2000a, b). However, March (2001) prefers to use Carlo Rubbia's modification of this concept in which the fragments are used to directly heat a conventional NTR propellant ( $H_2$ ) for propulsion, as described in item 2 above (Rubbia, 1999, 2000; Ronen et al., 2000a, b). In order for the fragments to escape from the nuclear fuel and reactor, a low-mass density critical reactor must be constructed. In order to design such a reactor, highly fissionable nuclear fuels such as Americium (Am) or Curium (Cm) must be used. These fairly rare fuels are produced from reprocessed spent nuclear fuel (via the extraction of Pu-241 and Am-241), which is a very expensive multistep process. However, small amounts of Am-242m are already available. Ronen et al. (2000a, b) demonstrate that Am-242m can maintain sustained nuclear fission as an extremely thin metallic film, less than  $1/1000^{\text{th}}$  of a millimeter thick. Am-242m requires only 1% of the mass of U-235 or Pu-239 to reach its critical state. It should be noted that obtaining fission fragments is not possible with U-235 and Pu-239 nuclear fuels because they both require



large fuel rods, which absorb their fission products. The fission fragment propulsion concept is near-term technology, however it requires the development of new technology and technology risk reduction.

We outline and summarize below the general vehicle design specifications and the vehicle performance case study, which illustrates the ETO performance capability of Nuclear DC-X (March, 2001):

- ❑ VTOL-SSTO Heavy Cargo Lifter
- ❑ Nuclear DC-X propulsion system: 5,000 MWt class LANTR engine
- ❑ Utilize Air Force Timber Wind PeBR (see below for discussion of Timber Wind) or Russian Zr-hydride heterogeneous reactor design with ternary-carbide fuels, operating at power densities  $\approx 20 - 40$  MWt/liter with reactor temperature of 3,000 K
- ❑ LANTR segmented aerospike exhaust nozzle with variable thrust control on each engine for attitude and flight trajectory control (no gimbaling): 5-throttled LANTR engines per vehicle
- ❑ Canard stabilator flight control surfaces
- ❑ Landing struts (5) perform multiple functions: provide vehicle support, aerodynamic control, heat rejection, and landing shock absorption
- ❑ X-33 type Metallic Reentry Thermal Protection System on the bottom of the vehicle, plus carbon-carbon leading edges on all landing struts/stabilators
- ❑ The LANTR engines are tilted inboard to place neutron shadow-shield between ground observers and the engines after lift-off – rely on the Conda-effect for flow turning on the aerospike exhaust nozzle
- ❑ Neutron shields: graphite-Al walled tanks filled with H<sub>2</sub>O loaded with <sup>10</sup>B
- ❑ LANTR engine Oxidizer/Fuel = 4:1
- ❑ LANTR engine run time = 200 seconds, total boost time = 500 seconds
- ❑ Nuclear DC-X is VTOL from any prepared concrete pad
- ❑ 40% GTOW can be carried to LEO (at 400 km altitude and 51° inclination) from a 45° latitude launch
- ❑ Dry vehicle mass fraction is 30%, thus giving a payload fraction of 10%, or a payload mass of 10<sup>5</sup> kg to orbit on each flight
- ❑ Launch cost estimate: \$150/kg of payload, if commercially developed and operated
- ❑ Launch cost estimate: \$85/kg of payload, if developed and operated by the U.S. government

Figures 24 – 28 show P. March's detailed schematics of the Nuclear DC-X/LANTR SSTO Heavy Cargo Lifter. This concept can easily be scaled down in size to accommodate smaller payloads.

The Timber Wind PeBR is a reference to the Special Access Program codenamed Timber Wind (Lieberman, 1992). Lieberman (1992) reported that the Office of the DoD Inspector General conducted

an investigation into Timber Wind and concluded that SDIO program managers abused the Special Access Program classification system, DoD regulations, and a Presidential Executive Order. The SDIO began an R&D program on a nuclear propulsion system for a rocket that would intercept hostile ballistic missiles. The organization considered the existing state-of-the-art nuclear propulsion technology based on a PeBR. Brookhaven National Laboratory developed the PeBR technology. The program existed during 1987 – 91, and it was protected under the Special Access Program classification system. The program's entire R&D budget was \$139 million. Grumman Aerospace Corp. (Bethpage, New York) was the lead contractor, Babcock and Wilcox (Lynchburg, Virginia) was the nuclear fuel contractor, and Sandia National Laboratory conducted the tests to prove the technology. The SDIO stopped funding Timber Wind at the end of 1991. However, the program was transferred to the Air Force, which renamed the program the Space Nuclear Thermal Propulsion program. The Air Force's program eventually languished and died due to an inability to obtain crucial interagency cooperative agreements and funding.

The significance of Timber Wind for this concept is twofold. First, the program advanced the state-of-the-art PeBR technology by demonstrating that a PeBR could power a NTR. Second, the program was scheduled to begin flight tests (ca. 1993 – 95) of a NTR ABM missile that would fly through the atmosphere and up to suborbital and orbital altitudes. This proves that operating a nuclear powered launch vehicle in the atmosphere is an (officially) acceptable endeavor. There were many other programs in the 1950's – 70's that considered nuclear power for aircraft or aerospace vehicle applications. These were eventually canceled due to the overwhelming alarm raised by environmentalists over the use of nuclear fuel to power aerospace vehicles. The intellectually bankrupt environmentalist movement used unwarranted fear and intimidation, plus distorted (mass media) public education campaigns, to aggressively manipulate the public and authorities in an attempt to curtail or end nuclear power and propulsion R&D (Bisconti and Livingston, 1992). Applying the PeBR to a LANTR propulsion application actually reduces the size, mass, radiation and shielding requirements of the rocket engine stage. This is an attractive practical design feature with a rocket exhaust radioactive contamination threat that is essentially zero. The ROVER/NERVA engine tests measured zero radioactive contamination in the rocket exhaust (Friedman, 2004). Tiny amounts of reactor core graphite debris were found to be present in the exhaust, but their radioactivity was zero. Essentially, a NTR operates for only a few hundred seconds or less during flight, which is not enough time to generate radioactive exhaust contaminates because the build-up of fission products is nil compared to a nuclear power reactor operating for a much longer time.

Nuclear fission propulsion systems have undergone extensive modeling and experimental validation over the past 50 years. This advanced propulsion concept is near-term because it can be deployed now. Further R&D work is required to continue maturing the LANTR and Am-242m fission fragment NTR technology. The former is near completion of its validation phase and needs to undergo engine hot-fire testing, while the latter requires the initiation of experimental testing of an engine design. R&D funding has been inadequate or not available on a consistent basis in recent years for reasons involving politics, agenda, legacy, or simple resistance to different ways of doing things. However, NASA's recent space nuclear power and propulsion program initiative will hopefully re-energize nuclear propulsion R&D in a very serious way. Nuclear DC-X has such far-reaching capabilities that it represents a new and vital way of realizing the benefits of space. This advanced propulsion concept can be implemented within 5 years to meet all manned and unmanned space mission requirements.

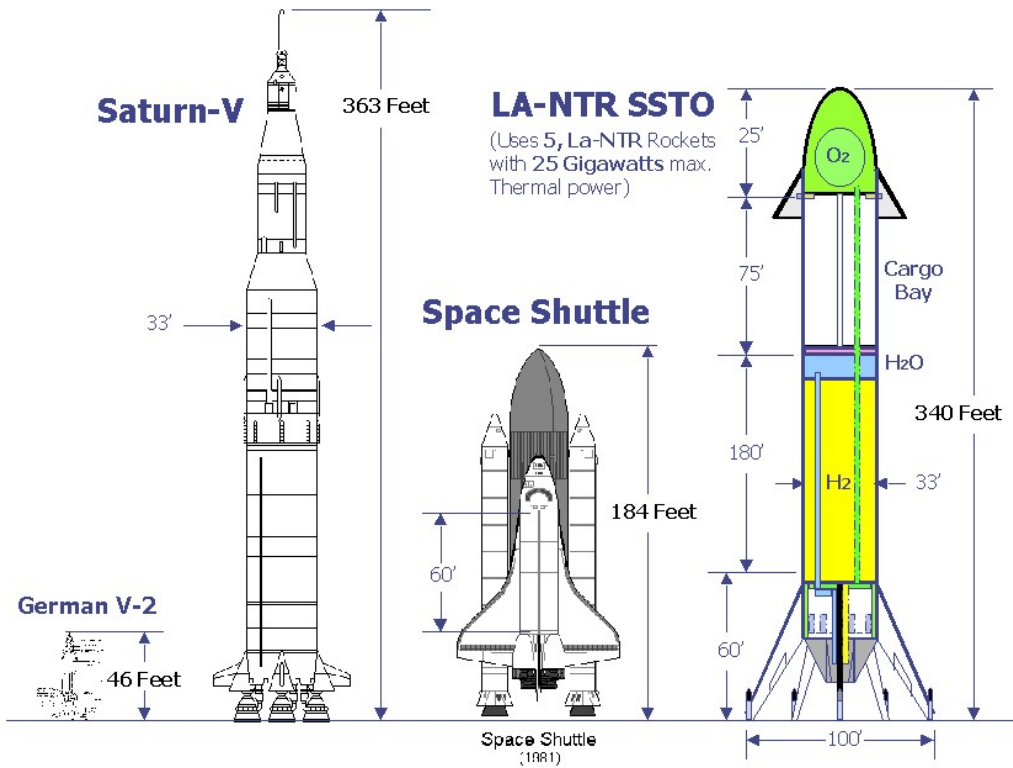


Figure 24. Nuclear DC-X/LANTR SSTO Heavy Cargo Lifter (March, 2001)

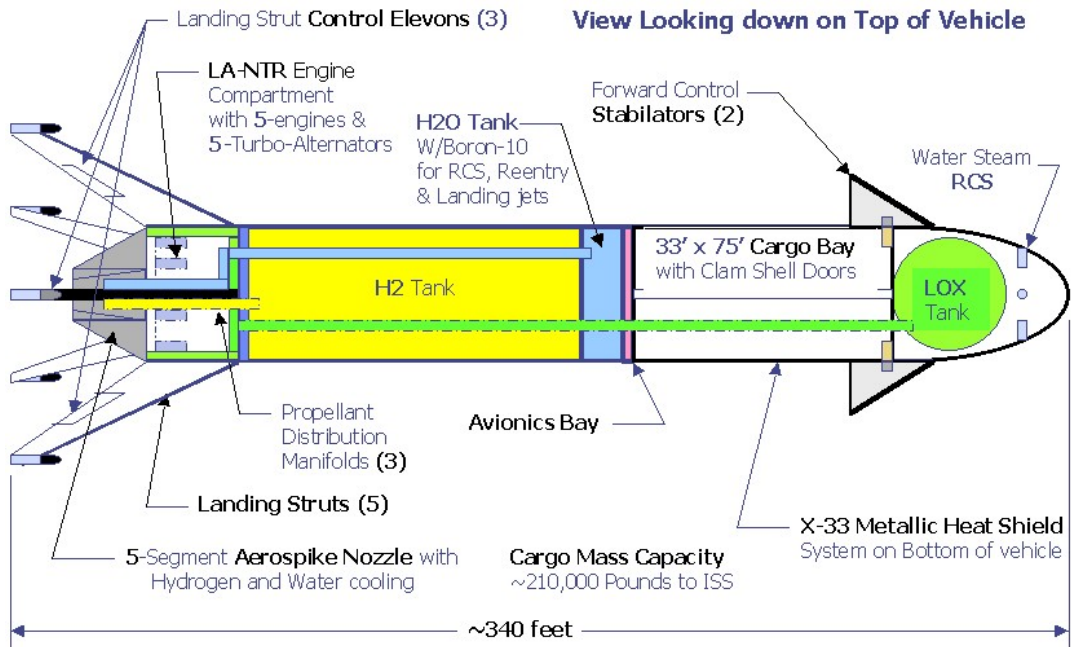


Figure 25. Nuclear DC-X/LANTR SSTO Heavy Cargo Lifter (March, 2001)

# LA-NTR Aerospike Nozzle Cross-Section

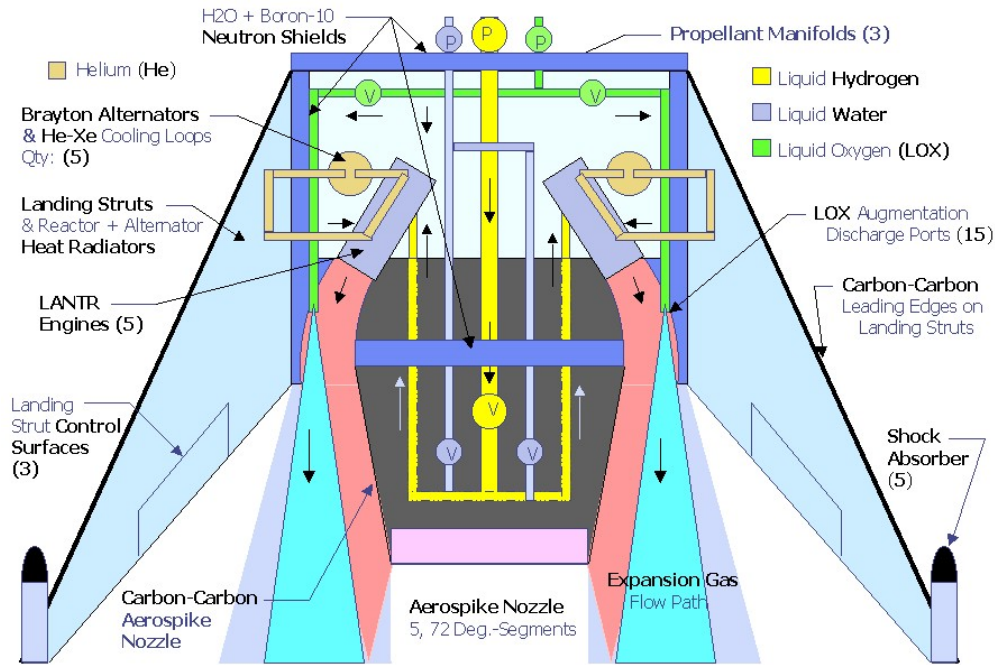


Figure 26. Nuclear DC-X/LANTR SSTO Heavy Cargo Lifter (March, 2001)

# LA-NTR Engine Compartment

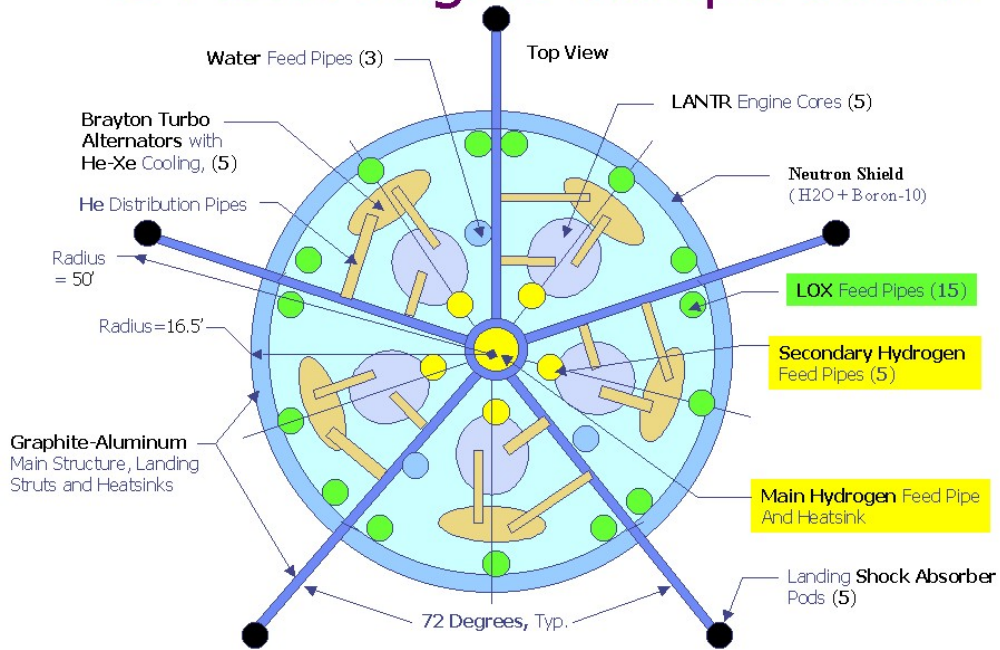


Figure 27. Nuclear DC-X/LANTR SSTO Heavy Cargo Lifter (March, 2001)

# Aerospike Nozzle Configuration

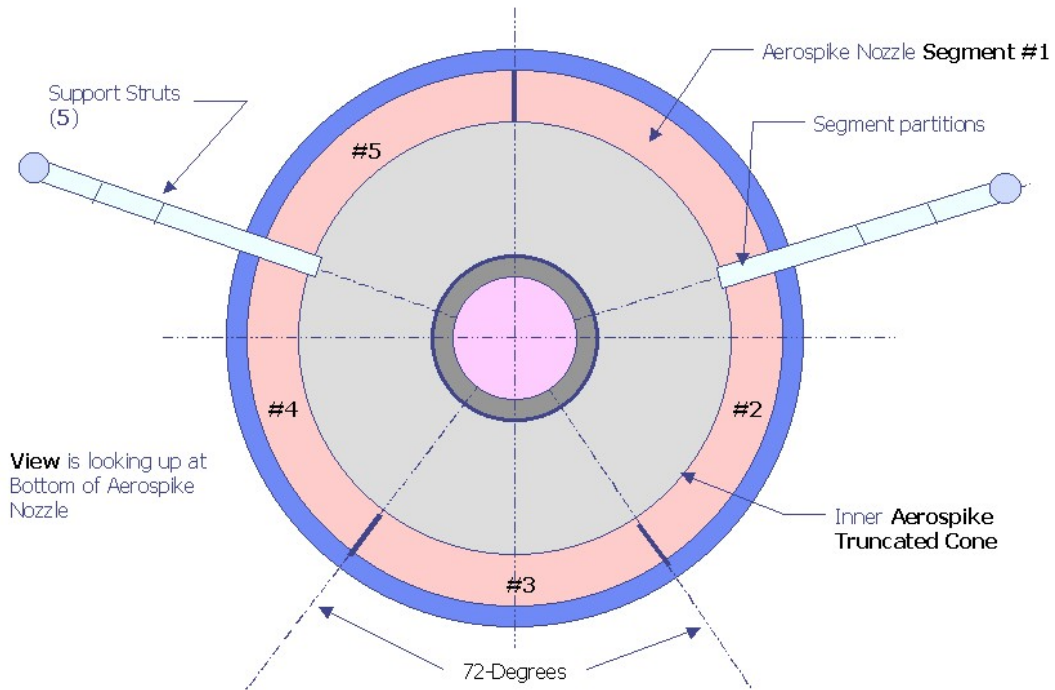


Figure 28. Nuclear DC-X/LANTR SSTO Heavy Cargo Lifter (March, 2001)

## Chapter 4 – Conclusion

### 4.1 Future Advanced Propulsion Concepts

The advanced propulsion concepts reviewed and discussed in this study were numerous. Many concepts were reviewed for the study, and many more were not considered for review. The guidelines or criteria used to examine, select and recommend advanced propulsion concepts for the study are based on the advanced concepts philosophy and operative guidelines outlined in Chapter 1. The recommended advanced propulsion concepts in Chapter 3 represent the best of the three propulsion categories involving advanced chemical, beamed-power, and nuclear technologies.

Now that the author has made recommendations to the AFRL, where do we go from here, or what does the future have in store for advanced propulsion concepts? The answer can be found by studying all that has been accomplished to date in the NASA Breakthrough Propulsion Physics (BPP) project. It is beyond the scope of the present study to give a comprehensive review of future advanced propulsion concepts. Such concepts are categorized as far-term because their technology readiness horizon is  $\geq 30$  years in the future. Forward (1987), Bennett et al. (1995a, b), Allen (2003) and Millis (2003a, b, c) provide an excellent overview of the numerous BPP concepts and their present state of modeling and experimental validation. These include concepts such as antigravity, gravitomagnetic and gravitoelectric fields, inertia or gravity modification/shielding, multi-space-dimensional quantum unified field theories (a.k.a. superstring, D-brane, quantum loops, or quantum hologram theories), alternative gravity theories, electrogravity theories, electromagnetic space drives, anisotropic mass tensor theories, quantum vacuum zero-point energy, warp drives, traversable wormholes, other faster-than-light (FTL) theories, quantum FTL effects, etc. The various BPP categories are too numerous to review here. The vast majority of BPP concepts are only relevant to interplanetary and/or interstellar flight applications, which is beyond the scope of the present study. A very large number of BPP concepts have little or no credibility because they lack modeling and/or experimental validation, or that existing models and experimental work suffer from a lack of rigor and/or a severe lack of independent experimental repeatability (again, lack of rigor). Many BPP concepts have been published in the academic peer-reviewed technical literature, and many have not (because they originate from the various underground alternative physics movements). However, there is a subset of excellent BPP concepts that are very credible and rigorous, but their modeling or experimental validation work lacks sufficient funding to proceed, or their experimental research presently gives inconclusive results.

In the following sections, the author summarizes recent BPP efforts that are directly relevant to ETO/LEO/GEO propulsion applications. The summary represents the author's own personal prejudices and is by no means complete. The author has several other favorite BPP concepts, but they are not included here for brevity, and simply because their modeling and/or experimental validation does not yet exist, or experimental results are presently inconclusive, or the work is not technically mature enough for one to be confident of its outcome. The author wishes to apologize in advance to fellow NASA BPP researchers for not including their work in this report. However, Millis (2003a, b, c) provides a very thorough overview of all the BPP concepts that were funded by NASA and other government or commercial industry organizations.

### 4.2 Quantum Vacuum Zero-Point Energy

Summary:

- Within the context of Quantum Field Theory the vacuum is the seat of all energetic particle and field fluctuations; primary among them is the quantum vacuum electromagnetic zero-point energy (ZPE) or zero-point fluctuations (ZPF).

- The quantum vacuum ZPE is comprised of virtual particle pairs (i.e., electron-positron pairs or any other matter-antimatter particle pairs), which are very short lived because of the large mismatch between the energy of a photon and the rest mass-energy of the virtual particle pair. [Note: In QFT a matter-antimatter particle pair annihilates with the result that their rest-mass energy is converted into a photon.]
- The energy density of the quantum vacuum electromagnetic ZPE is  $\leq 10^{107} \text{ J/cm}^3$ .

Warning:

1. If one imposes a ZPE mode wavelength cutoff and takes ZPE mode interactions into account in the energy density calculation, then the result remains an enormous number.
  2. One should ignore the heated technical debate between cosmologists and quantum field theorists over the reality of this number because there is presently no universally accepted theory that successfully bridges the gap between quantum field theory physics and spacetime physics.
  3. Astrophysical observations indicating that the vacuum spacetime energy density is  $\leq 10^{-15} \text{ J/cm}^3$  do not really measure the physical quantum vacuum energy density as claimed by cosmologists. Instead, observations are really measuring the geometrical strain energy of spacetime due to cosmological expansion of the universe.
- The quantum vacuum ZPE can be extracted to generate electrical power, which can then be used to power aerospace propulsion systems:
    - There already is extensive theoretical, and more importantly, experimental research proving that the vacuum can be engineered (or physically modified) so that the vacuum ZPE can be exploited (via the Casimir Effect, for example) to extract electrical energy or actuate microelectromechanical devices (see for example, Ambjørn and Wolfram, 1983; Forward, 1984, 1996, 1998; Puthoff, 1990, 1993a; Cole and Puthoff, 1993; Milonni, 1994; Mead and Nachamkin, 1996; Lamoreaux, 1997; Chan et al., 2001; and the references cited therein). But most of this research involves very low energy density regimes. The Mead and Nachamkin (1996) approach proposes the use of resonant dielectric spheres, slightly detuned from each other, to provide a beat-frequency downshift of the more energetic high-frequency components of the ZPE to a more easily captured form. All of this research represents the baby steps that have been recently taken toward achieving a breakthrough in the extraction of significant useful energy from the vacuum. This is very much like the baby steps that were taken from the advent of early 20<sup>th</sup> century radioisotope chemistry to the achievement of the neutron-catalyzed nuclear fission chain reaction process, which immediately led to the harnessing of nuclear energy for electrical power generation and military weapons.
    - Note: The typical energy density generated by a typical Casimir Effect device is  $\sim 10^{-5} \text{ J/cm}^3$ , which is  $10^{10}$  times larger (in magnitude) than the measured vacuum spacetime energy density (item 3 above); however, the Casimir Effect energy is actually a negative energy density because it is lower than the energy density of the surrounding free vacuum.
    - A catalyst process that efficiently coheres and converts the ZPE into significant quantities of useful energy will be discovered in the near-future.

- The ZPE may be used to modify inertia and/or gravity via electromagnetic or other means to generate a direct propulsion effect:
  - Sakharov (1968) suggested that gravity might actually be an induced effect brought about by changes in the ZPE of the vacuum, due to the presence of matter. This idea was never developed further. However, Puthoff (1989a, b, 1993b) developed a model whereby the gravitational interaction begins with the fact that a particle situated in the sea of electromagnetic ZPF develops a “jitter” motion (a.k.a. ZITTERBEWEGUNG). When there are two or more particles they are each influenced not only by the fluctuating background electromagnetic field, but also by the electromagnetic fields generated by the other particles, all similarly undergoing ZITTERBEWEGUNG motion, and the inter-particle coupling due to these fields results in the attractive gravitational force. Gravity can thus be understood as a kind of long-range Casimir force. The major benefit of the Puthoff’s approach is that it provides a basis for understanding various characteristics of the gravitational interaction hitherto unexplained. These include the relative weakness of the gravitational force under ordinary circumstances (shown to be due to the fact that the coupling constant  $G$  depends inversely on the large value of the high-frequency cutoff of the ZPF spectrum); the existence of positive but not negative mass (traceable to a positive-only kinetic-energy basis for the mass parameter); and the fact that gravity cannot be shielded (a consequence of the fact that quantum ZPF “noise” in general cannot be shielded, a factor which in other contexts sets a lower limit on the detectability of electromagnetic signals). If this model is correct, then we can alter or modify gravity by altering or modifying the vacuum ZPE. We return to this theme with more detail in Section 4.2.1. A dedicated research program will be necessary to develop and mature this propulsion concept.
  - A possible connection between the electromagnetic quantum vacuum and inertia was first published by Haisch et al. (1994). If correct, this would imply that mass might be an electromagnetic phenomenon and thus in principle subject to modification, with possible technological implications for propulsion. A multiyear NASA-funded study at the Lockheed Martin Advanced Technology Center further developed this concept, resulting in an independent theoretical validation of the fundamental approach (Rueda and Haisch, 1998a, b). Distortion of the quantum vacuum in accelerated reference frames results in a force that appears to account for inertia. Rueda et al. (2001) showed that the same effect occurs in a region of curved spacetime, thus elucidating the origin of the principle of equivalence. A further connection with General Relativity (GR) has been drawn by Nickisch and Mollere (2002): the ZPF give rise to spacetime micro-curvature effects yielding a complementary perspective on the origin of inertia. Numerical simulations of this effect demonstrate the manner in which a massless fundamental particle, e.g. an electron, acquires inertial properties; this also shows the apparent origin of particle spin along lines originally proposed by Schrödinger. The present model also suggests that the heavier leptons (muon and tau) may be explainable as spatial-harmonic resonances of the (fundamental) electron. They would carry the same overall charge, but with the charge now having spatially lobed structure, each lobe of which would respond to higher frequency components of the electromagnetic quantum vacuum, thereby increasing the inertia and thus manifesting a heavier mass. A dedicated research program will be necessary to develop and mature this propulsion concept.

#### 4.2.1 Engineering the Vacuum

The concept of “*engineering the vacuum*” was first introduced to the physics community by Lee (1988). Lee stated:



*“The experimental method to alter the properties of the vacuum may be called vacuum engineering...If indeed we are able to alter the vacuum, then we may encounter some new phenomena, totally unexpected.”*

This new concept is based on the now-accepted fact that the vacuum is characterized by physical parameters and structure that constitutes an energetic medium which pervades the entire extent of the universe (Milonni, 1994). We note here the two most important defining properties of the vacuum in this regard (Puthoff et al., 2002):

- ❑ Within the context of Quantum Field Theory the vacuum is the seat of all energetic particle and field fluctuations.
- ❑ Within the context of General Relativity Theory the vacuum is the seat of a spacetime structure (or metric) that encodes the distribution of matter and energy (Einstein, 1916).

We also know from quantum field theory that light propagating through space interacts with the vacuum quantum fields (a.k.a. vacuum quantum field fluctuations). The observable properties of light, including the speed of light, are determined by these interactions. Vacuum quantum interactions with light lead to an effect on the speed of light that is due to the absorption of photons (by the vacuum) to form virtual electron-positron pairs followed by the quick re-emission (from the vacuum) of the photon. The virtual particle pairs are very short lived because of the large mismatch between the energy of a photon and the rest mass-energy of the particle pair. A key point is that this process makes a contribution to the observed vacuum permittivity  $\epsilon_0$  (and permeability  $\mu_0$ ) constant and, therefore, to the speed of light  $c$  [ $c = (\epsilon_0\mu_0)^{-1/2}$ ].

The role of virtual particle pairs in determining the  $\epsilon_0$  ( $\mu_0$ ) of the vacuum is analogous to that of atoms/molecules in determining the relative permittivity  $\epsilon$  (and  $\mu$ ) of a dielectric material. We know that the absorption/re-emission of photons by atoms/molecules in a transparent medium (note: there are no strongly absorbing resonances, so the atoms/molecules remain in their excited states for a very short time before re-emitting photons) is responsible for the refractive index of the medium, which results in the reduction of the speed of light for photons propagating through the medium. This absorption/re-emission process is also known in physics as a scattering process. We know from experiment that a change in the medium leads to a change in  $\epsilon$  ( $\mu$ ), thus resulting in a change of the refractive index. The key point arising from this analogy is that a modification of the vacuum produces a change in  $\epsilon_0$  ( $\mu_0$ ) resulting in a subsequent change in  $c$ , and hence, a corresponding change in the vacuum refraction index.

Scharnhorst (1990) and Latorre et al. (1995) have since proved that the suppression of light scattering by virtual particle pairs (a.k.a. coherent light-by-light scattering) in the vacuum causes an *increase* in the speed of light accompanied by a decrease in the vacuum refraction index. This very unique effect is accomplished in a Casimir Effect capacitor cavity (or waveguide) whereby the vacuum quantum field fluctuations (a.k.a. zero-point fluctuations or ZPF) inside have been modified (becoming anisotropic and non-translational invariant) to satisfy the electromagnetic boundary conditions imposed by the presence of the capacitor plates (or waveguide walls). The principal result of this modification is the removal of the electromagnetic zero-point energy (ZPE) due to the suppression of vacuum ZPE modes with wavelengths longer than the cavity/waveguide cutoff ( $\lambda_0 = 2d$ , where  $d$  = plate separation). This removal of free space vacuum ZPE modes suppresses the scattering of light by virtual particle pairs, thus producing the speed of light increase (and corresponding decrease in the vacuum refraction index). We know from standard optical physics and quantum electrodynamics (QED) that the optical phase and group velocities can exceed  $c$  under certain physical conditions, but dispersion always ensures that the signal velocity is  $\leq c$ . But recent QED calculations (Scharnhorst, 1990; Latorre et al., 1995) have proved that in the Casimir Effect system, the dispersive effects are *much weaker* still than those associated with the increase in  $c$  so

that the phase, group and signal velocities will therefore *all increase* by the same amount. Note that, in general, no dispersion shows up in all of the modified vacuum effects examined by investigators.

The polarizable-vacuum representation of general relativity (a.k.a. PV-GR) treats the vacuum as a polarizable medium of variable refractive index (Puthoff, 1999, 2002a, b; Puthoff et al., 2002). The PV-GR approach treats spacetime metric changes in terms of equivalent changes in the vacuum permittivity and permeability constants ( $\epsilon_0$  and  $\mu_0$ ), essentially along the lines of the “ $TH\epsilon\mu$ ” methodology used in comparative studies of alternative metric theories of gravity (reviewed by Davis, 2004). Such an approach, relying as it does on parameters familiar to engineers, can be considered a “metric engineering” approach. Maxwell’s equations in curved space are treated in the isomorphism of a polarizable medium of variable refractive index in flat space (Volkov et al., 1971); the bending of a light ray near a massive body is modeled as due to an induced spatial variation in the refractive index of the vacuum near the body; the reduction in the velocity of light in a gravitational potential is represented by an effective increase in the refractive index of the vacuum, and so forth. This optical-engineering approach has been shown to be quite general (de Felice, 1971; Evans et al., 1996a, b).

As recently elaborated by Puthoff (1999, 2002a, b; Puthoff et al., 2002) the PV-GR approach, which was first introduced by Wilson (1921) and then developed by Dicke (1957, 1961), can be carried out in a self-consistent way so as to reproduce to appropriate order both the equations of general relativity and the match to the standard astrophysics weak-field experimental (PPN parameters and other) tests of those equations while posing testable modifications for strong-field conditions. It is in application that the PV-GR approach demonstrates its intuitive appeal and provides additional insight into what is meant by a curved spacetime metric.

Specifically, the PV-GR approach treats such measures as the speed of light, the length of rulers (atomic bond lengths), the frequency of clocks, particle masses, and so forth, in terms of a variable vacuum dielectric constant  $K$  in which the vacuum permittivity  $\epsilon_0$  transforms as  $\epsilon_0 \rightarrow K\epsilon_0$  and the vacuum permeability transforms as  $\mu_0 \rightarrow K\mu_0$  (see also Rucker, 1977). In a planetary or solar gravitational potential  $K = \exp(2GM/rc^2) > 1$  ( $M$  is a local mass distribution,  $r$  is the radial distance from the center of  $M$ ) while  $K = 1$  in “empty” or free asymptotic space (Puthoff, 1999, 2002a, b; Puthoff et al., 2002). In the former case, the speed of light is reduced, light emitted from an atom is redshifted as compared with a remote static atom (where  $K = 1$ ), clocks run slower, objects/rulers shrink, etc.

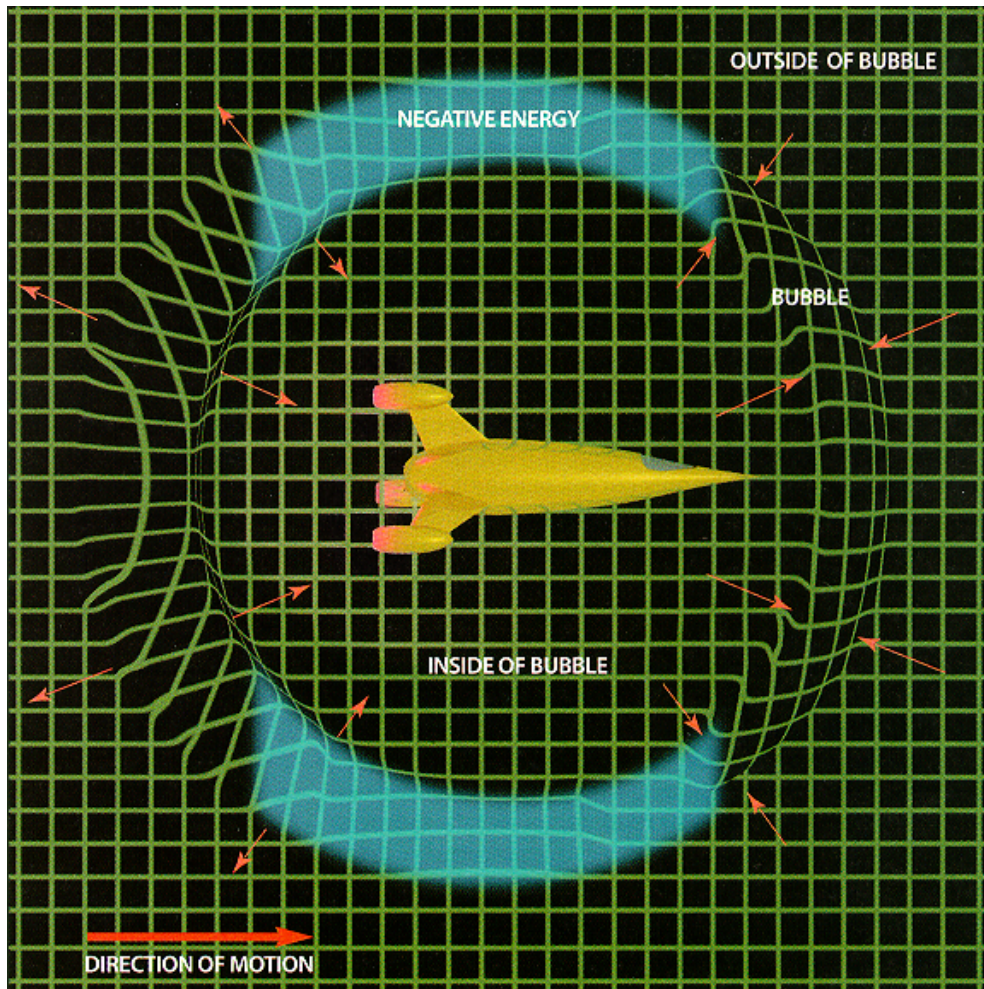
Davis (2004) reports that a small number of  $K < 1$  solutions were developed that describe FTL motion [i.e.,  $c$  is increased, or the vacuum refraction index  $< 1$ , when the modified vacuum has a lower energy density] which is generated by some distributed negative energy density such that the total energy density of the system as seen by remote observers is approximately zero. These solutions are similar in function to that of a traversable wormhole (see the next Section) or warp drive effect (Alcubierre, 1994), which both arose from Einstein’s General Relativity Theory and are both generated by distributed negative energy density in spacetime. On this basis, we therefore offer the following conjecture:

- An ETO propulsion concept can be envisioned whereby an aerospace vehicle uses specially engineered energy fields to modify the local gravity field (via modifying the vacuum index of refraction) so that the craft can be lifted from the Earth’s surface and propelled up to orbit. We can exploit this mechanism to propel an aerospace vehicle into and around space without having to necessarily engage any FTL motion. A dedicated research program will be necessary to develop and mature this propulsion concept.

### 4.3 Engineering the Spacetime Metric

Another way to engineer the spacetime metric is by resorting to the solutions provided by General Relativity Theory (Einstein, 1916). These are:

- The Alcubierre Warp Drive Effect: Alcubierre (1994) derived a spacetime metric that induces a bubble-shaped geometry surrounding a spacecraft, which uniquely allows for FTL motion through space without violating the Special Theory of Relativity. A thin shell of negative energy (i.e., “exotic” energy; referring to forms or states of mass-energy that violate general relativity energy condition theorems, which are now invalid) must be distributed around the spacecraft in order to generate the warp-bubble geometry (see Figure 29). Krasnikov (1998) and Van Den Broeck (1999) proposed refinements to the warp-bubble geometry. This concept will not be considered further in the study because it is best suited for interstellar flight applications, and the negative energy density required to generate FTL motion is presently estimated to be on the order of a stellar mass. The concept is presently undergoing further refinement and technical study.
  
- The Levi-Civita Effect: Levi-Civita (1917) considered the possibility of generating a uniform static magnetic or electric field (possessing cylindrical symmetry) to create an artificial gravitational field in accordance with GR (Pauli, 1981). The author (Davis, 1998, 1999) showed that Levi-Civita’s spacetime metric describes a spatial hypercylinder with a position dependent gravitational potential. The geometry is interesting from the standpoint that it describes a unique cylindrically shaped “trapped” space. The author (Davis, 1998, 1999) further showed that magnetic field strengths would have to be  $10^9 < B_{\text{field}} \leq 10^{18}$  Tesla in order to induce a spacetime curvature (a geometrical measure of gravitational potential) of  $10^9 > a_{\text{curv}} \geq 1$  meters, where  $a_{\text{curv}}$  is the radius of spacetime curvature. A pulsed-power field generator could be used to generate an electric or magnetic field driven propulsion. Puthoff et al. (2004) studied the Levi-Civita Effect within the context of the PV-GR model. They showed how the perturbation of the spacetime metric by the presence of uniform static magnetic and electric fields can be understood as a perturbation of the effective refractive index of the vacuum, and summarized in terms of its effect on the propagation of a light ray through the region containing the fields. If the PV-GR model is correct, then modifying the vacuum index of refraction using electric or magnetic fields could induce a unique form of propulsion. A dedicated research program will be necessary to develop and mature this propulsion concept.



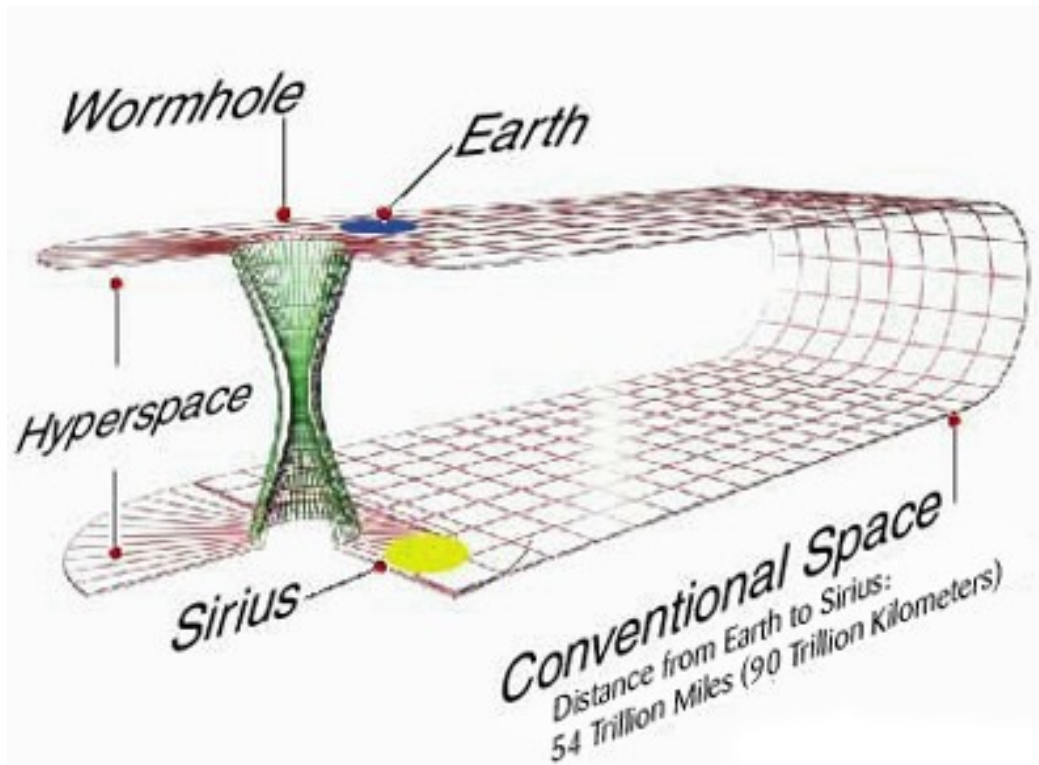
**Figure 29. The Alcubierre Warp Drive**

(from [www.physics.hku.hk/~tboyce/sf/topics/wormhole/wormhole.html](http://www.physics.hku.hk/~tboyce/sf/topics/wormhole/wormhole.html))

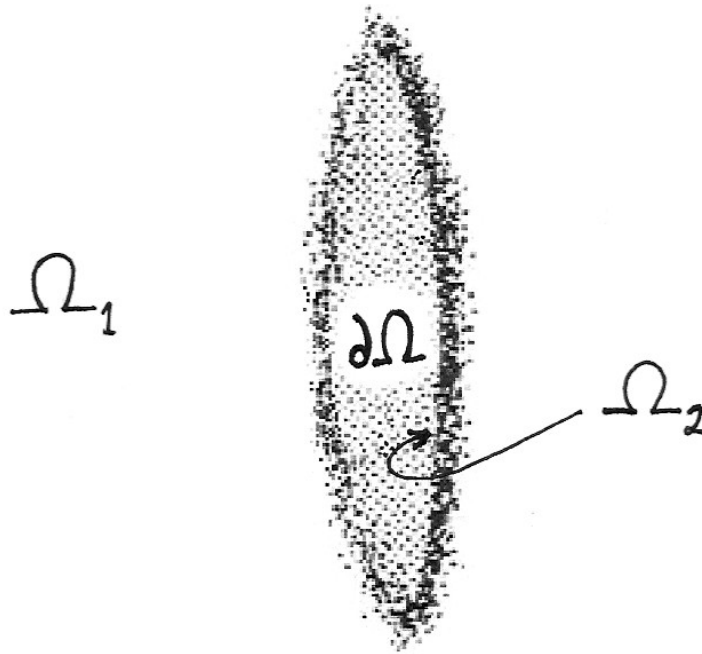
Note the negative energy distributed around the spacecraft.

- Traversable Wormholes: Morris and Thorne (1988), with further refinement by Visser (1995), derived a spacetime metric that generates a traversable wormhole (or hyperspace tunnel) geometry in spacetime. This unique geometry allows space travelers to enter one side of the tunnel, travel through the throat, and exit out the other side. There is actually no real FTL motion involved when traveling through a traversable wormhole. That is because wormholes are a (hyperspace) shortcut through the universe, whereby space travelers can traverse enormous astronomical distances within a matter of a few minutes or days while traversing only a few meters or kilometers through the throat/tunnel (see Figure 30). Wormholes are hyperspace tunnels through spacetime connecting together either different remote regions within our universe or two different universes; they can even connect together different space dimensions and different times. Wormholes can possess normal or backwards (in special cases) time flow, normal or nonexistent gravitational stresses on space travelers, and their entry/exit openings (or throats) can be spherically shaped, cubic shaped, polyhedral shaped, or generic shaped, etc. A byproduct of wormhole studies has been the development of wormholes possessing flat entry/exit openings (Davis, 2004). This is essentially a true “stargate” or flat doorway/portal through

spacetime and space dimensions (see Figure 31). A thin shell of negative (i.e., “exotic”) energy must be distributed locally in order to generate the wormhole geometry (see Figure 32). It has been shown (Visser, 1995; Davis, 2004) that the amount of negative energy required to create and stabilize a 1-meter radius wormhole throat is  $-0.71 M_J$  ( $M_J = 1.90 \times 10^{27}$  kg, the mass of planet Jupiter). However, Visser et al. (2003) demonstrated the existence of spacetime geometries containing traversable wormholes that are supported by arbitrarily small quantities of negative energy, and they proved that this was a general result. A traversable wormhole can be envisioned to facilitate ETO transportation via a portal that connects a location on the Earth’s surface with a location in LEO or GEO (or elsewhere). The author (Davis, 2004) reviewed and summarized a few schemes that might allow one to engineer a traversable wormhole in the lab. It is known that static radial electric or magnetic fields are borderline “exotic” when threading a wormhole, if their tension were infinitesimally larger, for a given energy density (Herrmann, 1989; Hawking and Ellis, 1973). Other exotic matter-energy fields are known to be squeezed quantum states of the electromagnetic field (i.e., squeezed light) and other squeezed quantum fields, gravitationally squeezed vacuum electromagnetic zero-point energy, Casimir (electromagnetic zero-point) energy, and other quantum fields/states/effects (see Davis, 2004 for a description of squeezed quantum states/fields). The author (Davis, 1998, 1999, 2004) proposes using nuclear explosion magnetic compression or ultrahigh-intensity tabletop lasers to explore the possibility of creating a wormhole in the lab. A dedicated research program will be necessary to develop and mature this propulsion concept.

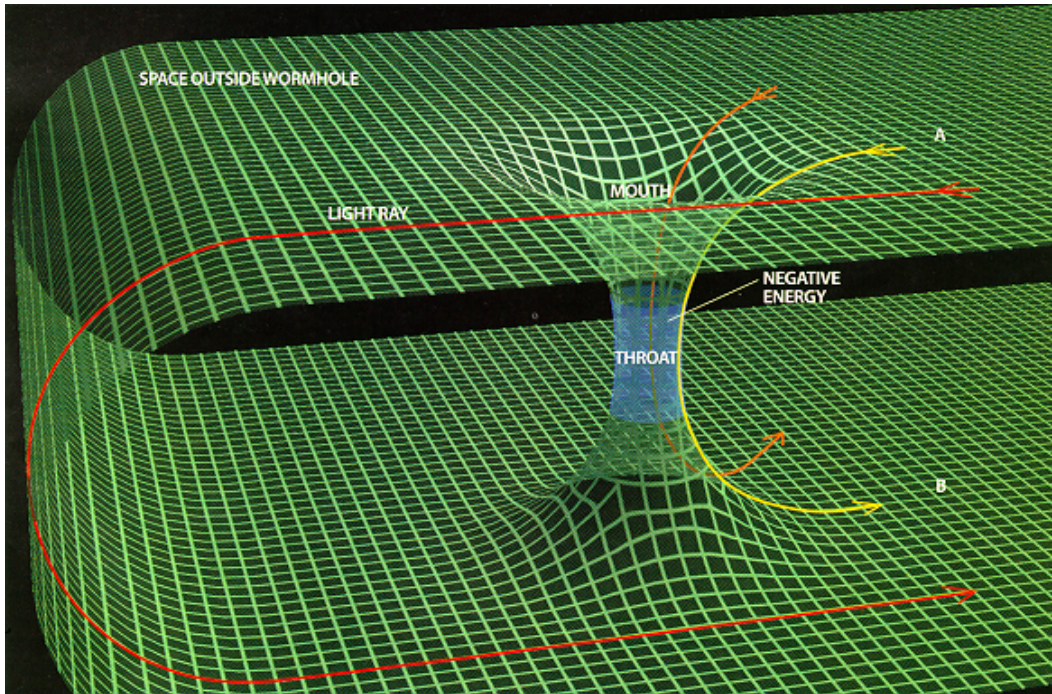


**Figure 30. Embedding Diagram For A Traversable Wormhole That Connects Two Distant Regions Of Our Universe**  
 (from <http://science.howstuffworks.com/time-travel4.htm>)



**Figure 31. Realistic Illustration Of A Traversable Wormhole With A Flat Entry/Exit, Which Is Essentially A True “Stargate” Or Flat Doorway Or Portal Through Spacetime (Davis, 2004)**

An observer sitting in region  $\Omega_1$  looks through the portal/stargate (wormhole throat  $\partial\Omega$ ) and sees remote region  $\Omega_2$  (dotted area inside the circle) on the other side. A traveler encountering and going through such a portal will feel no tidal gravitational forces and will not see or feel the negative energy that threads the throat. A traveler stepping through the portal will simply be shunted into the remote spacetime region (or another universe).



**Figure 32. Embedding Diagram For A Traversable Wormhole That Connects Two Distant Regions Of Our Universe**

(from [www.physics.hku.hk/~tboyce/sf/topics/wormhole/wormhole.html](http://www.physics.hku.hk/~tboyce/sf/topics/wormhole/wormhole.html)).

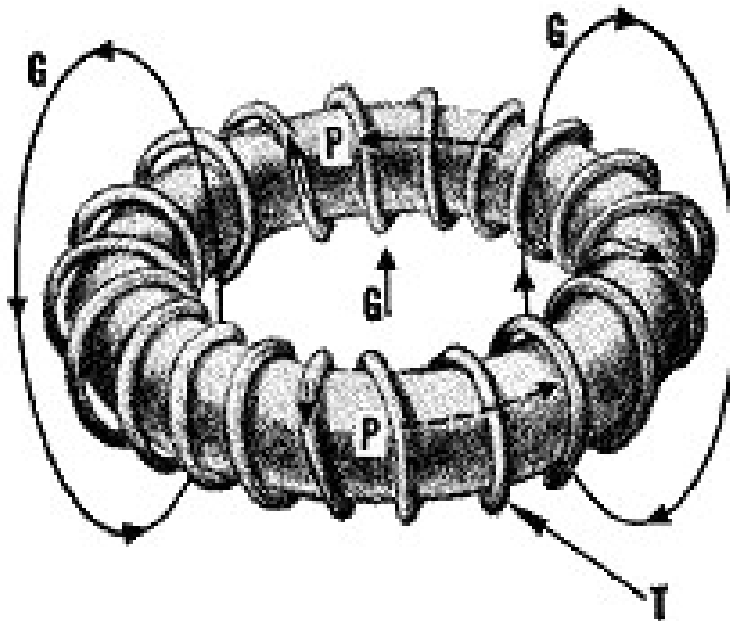
Note the negative energy distributed inside the throat.

- Antigravity: The concept of gravitation is based on the observed fact that a distribution of mass-energy attracts other distributions of mass-energy. Therefore, the force of gravitation is attractive. Antigravity is then just the opposite of gravity, that is, it is a repulsive force between two distinct distributions of mass-energy. Einstein's General Relativity Theory offers two forms of antigravity:
  1. Non-Newtonian Gravitational Forces (a.k.a. Gravitomagnetic Forces): Heaviside (ca. 1880's), Einstein (prior to the 1916 publication of his General Relativity Theory) and Thirring (1918, 1921; see also Mashhoon et al., 1984) showed that General Relativity Theory provides a number of ways to generate non-Newtonian gravitational forces. These forces could be used to counteract the Earth's gravitational field, thus acting as a form of antigravity. General Relativity Theory predicts that a moving mass can create forces on a test body which are similar to the usual centrifugal and Coriolis forces, although much smaller in magnitude. These forces create accelerations on a test body that are independent of the mass of the test body, and the forces are indistinguishable from the usual Newtonian gravitational force. We can counteract the Earth's gravitational field by generating these forces in an upward direction at some spot on the Earth. Forward (1961a) linearized the General Relativity field equations and developed a set of dynamic gravitational field relations similar to the Maxwell electromagnetic field relations. Forward (1961b, 1963) used these linear relations to develop models for generating antigravity forces. One example of an antigravity generator is based on a system of accelerated masses whose mass flow can be approximated by the electrical current flow in a wire-wound torus (via the analogy between Maxwell's electromagnetic field relations and the linearized dynamic gravitational field relations). Forward (1961b, 1963)

showed that we would need to accelerate matter with the density of a dwarf star through pipes wide as a football field wound around a torus with kilometer dimensions in order to produce an antigravity field (at the center of the torus) of  $\approx 10^{-10} a_{\text{acc}}$ , where  $a_{\text{acc}}$  is the acceleration of the (dwarf star density) material through the pipes (see Figure 33). The tiny factor  $10^{-10}$  is composed of the even smaller “gravitational permeability of space” ( $\eta = 3.73 \times 10^{-26}$  m/kg), which is the reason why very large systems are required to obtain even a measurable amount of acceleration. To counteract the Earth’s gravitational field of 1 g (or  $9.81 \text{ m/sec}^2$ ) requires an antigravity field of 1 g (vectored upward), and thus the dwarf star density material within the pipes must achieve  $a_{\text{acc}} = 10^{11} \text{ m/sec}^2$  in order to accomplish this effect. We presently do not have the technology to achieve this. Further R&D must be done in order to assess alternative technical schemes that can generate very strong antigravity fields. Important technical clue: We know from electromagnetism that the permeability of some materials such as iron is nonlinear, which allows for the construction of highly efficient electromagnetic field generators. A material possessing a highly nonlinear  $\eta$  would also be useful in the construction of efficient gravitational field generators. Studies of the vacuum ZPE and exotic quantum states of matter (i.e., Bose or Fermionic condensates) might help us in this regard.

2. Negative Energy: The same kind of negative (or “exotic”) energy that is required to create a traversable wormhole or warp drive effect can also generate antigravity. Negative energy and negative stress-tensions are an acceptable result (both mathematically and physically) in GR and QFT, and they manifest gravitational repulsion (a.k.a. antigravity) in and around the traversable wormhole throat or on the warp drive bubble. The author gives a technical definition and thorough discussion of negative energy elsewhere (Davis, 2004). If one could generate and distribute a thin shell of negative energy around an aerospace vehicle, then it will be possible to induce an antigravity field that counteracts the Earth’s gravitational field and lifts the craft up from the surface and propel it to orbit. This is a unique form of what the BPP research community euphemistically calls “propellantless” or “field” propulsion. As we saw in previous paragraphs, the vacuum ZPE is a source of negative energy. The author is presently working on formalizing this propulsion concept.





**Figure 33. Generator Of A Dipole Repulsive Gravity (“Antigravity”) Field (G) Through the Center of the Torus,**  
 where  $T$  is the mass flow and  $P$  is the gravitational equivalent to the magnetic field (Forward, 1963)

#### 4.4 The Walker Aerospace Commission Policy Recommendations

We conclude this report by noting that the vacuum ZPE makes an appearance in all of the different propulsion physics concepts described in the previous two sections. This is fortuitous because the Walker et al. (2002) Aerospace Commission Report made the following policy recommendations:

- “Achieve Breakthroughs in Propulsion and Space Power.” – Executive Summary
- “New propulsion concepts based on breakthrough energy sources, ...could result in a new propulsion paradigm that will revolutionize space transportation.” (p. 9-5)
- “In the longer-term, breakthrough energy sources that go beyond our current understanding of physical laws, ...must be credibly investigated in order for us to practically pursue human exploration of the solar system and beyond. These energy sources should be the topic of a focused, basic research effort.” (p. 9-6)
- In Figure 9-3 on page 9-9, “zero-point” is listed under “Breakthrough Energy Sources.”

These recommendations give us our marching orders and points the way to success. Politics, agenda, legacy, and the resistance to different ways of doing things all have to be vanquished in order to achieve successful breakthroughs so that we can move forward in a meaningful way. Ad Astra!

## Advanced Propulsion References

1. Alcubierre, M. (1994), "The warp drive: Hyper-fast travel within general relativity," *Class. Quant. Grav.*, 11, L73-L77
2. Allen, J. E. (2003), "Quest for a novel force: a possible revolution in aerospace," *Prog. In Aerospace Sci.*, 39, 1-60
3. Ambjørn, J. and Wolfram, S. (1983), "Properties of the Vacuum. I. Mechanical and Thermodynamic," *Annals Phys.*, 147, 1-32
4. Arnold, R. and Kingsbury, D. (1979a), "The Spaceport, Part I," *Analog Science Fiction-Science Fact*, 99, no. 11, 48-67
5. Arnold, R. and Kingsbury, D. (1979b), "The Spaceport, Part II," *Analog Science Fiction-Science Fact*, 99, no. 12, 60-77
6. Arnold, W., et al. (1979), "Mass Drivers (parts I, II and III)," in Proc. of the 1977 NASA-AMES Summer Study: Space Resources and Space Settlements, NASA SP-428, U.S. Gov't Printing Office
7. Artsutanov, Y. (1969), "Into Space Without Rockets," *Znanije-Sila*, 7, 25 (English translation: Report No. ADA084507, Air Force Systems Command, WPAFB, Ohio, 1969)
8. Bacarat, W. A. and Butner, C. L. (1986), Tethers in Space Handbook, prepared for NASA, Bantam Books, 4-32
9. Bakirov, I. T. and Mitrofanov, V. V. (1976), "High Velocity Two-Layer Detonation in an Explosive Gas System," *Soviet Phys. Doklady*, 21, 704-706
10. Bangham, M., Lorenzini, E., and Vestal, L. (1998), Tether Transport System Study, NASA TP-1998-206959
11. Barnes, D. C. and Nebel, R. A. (1993), Inertial Electrostatic Confinement Experiments at Low Working Pressure, NTTR101, NambeTech, Inc., Santa Fe, NM
12. Barr, W. L. and Moir, R. W. (1983), "Test Results on Plasma Direct Convertors," *Nucl. Tech. and Fusion*, 3, 98
13. Baumgartner, R. I. (1997), "VentureStar Single Stage To Orbit Reusable Launch Vehicle Program Overview," in Proc. of the STAIF 2<sup>nd</sup> Conference on Next Generation Launch Systems, AIP Conference Proceedings 387, ed. M. S. El-Genk, AIP Press, pp. 1033-1039
14. Baumgartner, R. I. (1998), "VentureStar – A Revolutionary Space Transportation Launch System," in Proc. of the STAIF 3<sup>rd</sup> Conference on Next Generation Launch Systems, AIP Conference Proceedings 420, ed. M. S. El-Genk, AIP Press, pp. 867-874
15. Bekey, I. (2003), Advanced Space System Concepts and Technologies: 2010 – 2030+, The Aerospace Press, El Segundo, CA, and AIAA, Inc., Reston, VA

16. Bekey, I. (1983), "Tethers Open New Space Options," *Astronautics and Aeronautics*, 21, 32
17. Benford, J. and Swegle, J. (1992), High Power Microwaves, Artech House, Boston, MA
18. Bennett, G. L., Forward, R. L. and Frisbee, R. H. (1995a), "Report on the NASA/JPL Workshop on Advanced Quantum/Relativity Theory Propulsion," AIAA-95-2599, 31<sup>st</sup> AIAA/ASME/SAE/ASEE Joint Propulsion Conference and Exhibit, San Diego, CA
19. Bennett, G. L., Forward, R. L. and Frisbee, R. H. (1995b), "Possible Applications of Advanced Quantum/Relativity Theory Propulsion to Interstellar Exploration: Report of a NASA/JPL Workshop," IAA-95-IAA.4.1.07, 46<sup>th</sup> Int'l Astronautical Congress, Oslo, Norway
20. Bennett, G. and Miller, T. (1991), "The NASA Program Plan for Nuclear Propulsion," in Proc. of the 8<sup>th</sup> Symposium on Space Nuclear Power Systems, Albuquerque, NM
21. Bertolini, L. R., et al. (1993), "SHARP, A First Step Towards a Full Sized Jules Verne Launcher," in Space Manufacturing 9, Proc. of the 11<sup>th</sup> SSI-Princeton Conference, pp. 79-86
22. Birch, P. (1983a), "Orbital Ring Systems and Jacob's Ladders – II," *J. British Interplanetary Soc.*, 36, 115
23. Birch, P. (1983b), "Orbital Ring Systems and Jacob's Ladders – III," *J. British Interplanetary Soc.*, 36, 231
24. Birch, P. (1982), "Orbital Ring Systems and Jacob's Ladders – I," *J. British Interplanetary Soc.*, 35, 475-497
25. Birkan, M. A. (1992), "Laser Propulsion: Research Status and Needs," *J. Propul. and Power*, 8, 354-360
26. Bisconti, A. S. and Livingston, R. L. (1992), Communicating with the Public About Radiation: An Assessment of Public Attitudes About Radiation, and Their Implications for Communication and Education Programs, U.S. Council for Energy Awareness
27. Bogdanoff, D. W. (1992), "Ram Accelerator Direct Space Launch System – New Concepts," *J. Propul. and Power*, 8, 481-490
28. Bogdanoff, D. W. and Higgins, A. J. (1996), "Hydrogen Core Techniques for the Ram Accelerator," AIAA-96-0668, AIAA 34<sup>th</sup> Aerospace Sciences Meeting and Exhibit, Reno, NV
29. Bogdanoff, D. W. and Miller, R. J. (1995), "Improving the Performance of Two-Stage Gas Guns by Adding a Diaphragm in the Pump Tube," *Int'l J. Impact Engr.*, 17, 81-92
30. Bohl, R. J. and Boudreau, J. E. (1987), "Direct Nuclear Propulsion: A White Paper," Los Alamos National Laboratory, Los Alamos, NM
31. Borowski, S. K., Culver, D. W., and Bulman, M. J. (1995), "Human Exploration and Settlement of the Moon Using LUNOX-Augmented NTR Propulsion," in Proc. of the 12<sup>th</sup> Symposium on Space Nuclear Power and Propulsion, AIP Conference Proc. 324, Vol. 1, eds. M. S. El-Genk and M. D. Hoover, AIP Press, New York, pp.409-420

32. Borowski, S. K., et al. (1994), "A Revolutionary Lunar Space Transportation System Architecture Using Extraterrestrial LOX-Augmented NTR Propulsion," AIAA-94-3343, AIAA/ASME/SAE/ASEE 30<sup>th</sup> Joint Propulsion Conference, Indianapolis, IN
33. Borowski, S. K. (1991), "The Rationale/Benefits of Nuclear Thermal Rocket Propulsion for NASA's Lunar Space Transportation System," AIAA-91-2052, AIAA/ASME/SAE/ASEE 27<sup>th</sup> Joint Propulsion Conference, Sacramento, CA
34. Borowski, S. K. (1990), "Nuclear Thermal Rocket Baseline Design – Rover/NERVA," in NASA Nuclear Propulsion Workshop, NASA-Lewis Research Center, Cleveland OH
35. Borowski, S. K. (1988), "Nuclear Propulsion – A Vital Technology for the Exploration of Mars and the Planets Beyond," in Proc., Minicourse on Fusion Applications in Space, American Nuclear Society Topical Meeting on Fusion Technology, Salt Lake City, UT, pp. 350-397
36. Brakke, K. A. (1982), "The Skyrail," L-5 News (July issue), 6-9
37. Brast, D. E. and Sawle, D. R. (1965), Feasibility Study for Development of a Hypervelocity Gun, Final Report NASA Contract NAS 8-11204
38. Bresie, D. A., et al. (1995), "SPEAR Coilgun," IEEE Trans. on Magnetics, 31, 467-472
39. Bull, G. V. and Murphy, C. H. (1988), Paris Kanonen – The Paris Guns (Wilhelmsgeschuetze) and Project HARP, Verlag Mittler, Bonn, Germany
40. Bussard, R. W. (1997), "System Technical and Economic Features of QED-Engine-Driven Space Transportation," AIAA-97-3071, AIAA/ASME/SAE/ASEE 33<sup>rd</sup> Joint Propulsion Conference, Seattle, WA
41. Bussard, R. W. (1993), "The QED Engine System: Direct-Electric Fusion-Powered Rocket Propulsion Systems," in Proc. of the 10<sup>th</sup> Symposium on Space Nuclear Power and Propulsion, AIP Conference Proc. 271, Vol. 3, eds. M. S. El-Genk and M. D. Hoover, AIP Press, New York, pp. 1601-1611
42. Bussard, R. W. (1992), "Method and Apparatus For Creating and Controlling Nuclear Fusion Reactions," U.S. Patent No. 5,160,695
43. Bussard, R. W. (1991), "Some Physics Considerations of Magnetic Inertial-Confinement: a New Concept for Spherical Converging-Flow Fusion," Fusion Technology, 19, 271-293
44. Bussard, R. W. (1990), "Fusion as Electric Propulsion," J. Propul., 6, 567
45. Bussard, R. W. (1989), "Method and Apparatus For Controlling Charged Particles," U.S. Patent No. 4,826,626
46. Bussard, R. W. and Froning, H. D. (1998), "System/Subsystem Engineering Interface Considerations and R&D Requirements for IEF/QED Engine Systems," in Proc. of the 15<sup>th</sup> Symposium on Space Nuclear Power and Propulsion, AIP Conference Proc. 420, Vol. 3, ed. M. S. El-Genk, AIP Press, New York, pp. 1344-1351

47. Bussard, R. W. and Jameson, L. W. (1995), "From SSTO to Saturn's Moons: Superperformance Fusion Propulsion for Practical Spaceflight," in Fusion Energy in Space Propulsion, Progress in Astronautics and Aeronautics, Vol. 167, ed. T. Kammash, AIAA Press, Washington DC, pp. 143-159
48. Bussard, R. W. and Jameson, L. W. (1994), "Design Considerations for Clean QED Fusion Propulsion Systems," in Proc. of the 11<sup>th</sup> Symposium on Space Nuclear Power and Propulsion, AIP Conference Proc. 301, Vol. 3, eds. M. S. El-Genk and M. D. Hoover, AIP Press, New York, pp. 1289-1296
49. Bussard, R. W. and Jameson, L. W. (1993), "The QED Engine Spectrum: Fusion-Electric Propulsion for Air-Breathing to Interstellar Flight," AIAA-93-2006, AIAA/ASME/SAE/ASEE 29<sup>th</sup> Joint Propulsion Conference, Monterey, CA
50. Bussard, R. W., Jameson, L. W., and Froning, H. D. (1993), "The QED Engine: Fusion-Electric Propulsion for CIS-Oort/Quasi-Interstellar (QIS) Flight," in Proc. of the 44<sup>th</sup> IAF Congress, 7<sup>th</sup> Interstellar Space Exploration Symposium, IAA-93-708, Graz, Austria
51. Carrier, G., Fendell, F., and Wu, F. (1995), "Projectile Acceleration in a Solid-Propellant-Lined Tube," Combustion Sci. and Tech., 104, 1-17
52. Chan, H. B., et al. (2001), "Quantum Mechanical Actuation of Microelectromechanical Systems by the Casimir Force," Science, 291, 1941-1944
53. Chapline, G. (1988), "Fission Fragment rocket concept," Nucl. Instr. and Meth., A271, 207-208
54. Chapman, P. K. (1981), "Bolos for Space Transportation," unpublished paper submitted to the 1981 NASA-Lewis Advanced Propulsion Competition
55. Chi, J., et al. (1990), "NERVA Derivative Reactors and Space Electric Propulsion Systems," in Proc. of the 7<sup>th</sup> Symposium on Space Nuclear Power Systems, Albuquerque, NM, pp. 208-213
56. Cinnamon, J. D. (1992), Nuclear Thermal Rocket Propulsion: Design Issues and Concepts, Texas Space Grant Consortium, University of Texas at Austin
57. Clark, E. N., et al. (1960), "Studies of hypervelocity impact on lead," in Proc. of the 4<sup>th</sup> Hypervelocity Impact Symposium, Eglin AFB, Florida
58. Clarke, A. C. (1981), "The Space Elevator: 'Thought Experiment' or Key to the Universe?," Advanced Earth Oriented Appl. Space Tech., 1, 39-48
59. Clarke, A. C. (1950), "Electromagnetic Launching as a Major Contribution to Space Flight," J. British Interplanetary Soc., 2, no. 6
60. Cole, D. C. and Puthoff, H. E. (1993), "Extracting Energy and Heat from the Vacuum," Phys. Rev. E, 48, 1562-1565
61. Cook, S. (1996), "The X-33 Advanced Technology Demonstrator," AIAA-96-1195, AIAA Dynamics Specialists Conference, Salt Lake City, UT

62. Cosmo, M. L. and Lorenzini, E. C. eds. (1997), NASA Tethers In Space Handbook – Third Edition, Smithsonian Astrophysical Observatory, NASA-MSFC Grant NAG8-1160, Huntsville, AL
63. Crozier, W. D. and Hume, W. (1957), “High-Velocity, Light-Gas Gun,” *J. Appl. Phys.*, 28, 892-894
64. Davis, E. W. (2004), Teleportation Physics Study, Final Report AFRL-PR-ED-TR-2003-0034, Air Force Research Laboratory, Air Force Materiel Command, Edwards AFB, CA
65. Davis, E. W. (1999), “Wormhole Induction Propulsion (WHIP),” in NASA Breakthrough Propulsion Physics Workshop Proceedings, NASA CP-1999-208694, pp. 157-163
66. Davis, E. W. (1998), “Interstellar Travel by Means of Wormhole Induction Propulsion (WHIP),” in Proc. of the 15<sup>th</sup> Symposium on Space Nuclear Power and Propulsion, AIP Conference Proceedings 420, ed. M. S. El-Genk, AIP Press, pp. 1502-1508
67. Dearien, J. (1990), “Report to the Nuclear Propulsion Steering Committee by the Reactor and Propulsion Panels, 18 September 1990,” in NEP/NTP Workshop Feedback Meeting, Houston, TX
68. de Felice, F. (1971), “On the gravitational field acting as an optical medium,” *Gen. Rel. Grav.*, 2, 347-357
69. Dicke, R. H. (1961), “Mach’s principle and equivalence,” in Proc. of the Int’l School of Physics “Enrico Fermi” Course XX, Evidence for Gravitational Theories, ed. C. Møller, Academic Press, New York, pp. 1-49
70. Dicke, R. H. (1957), “Gravitation without a principle of equivalence,” *Rev. Mod. Phys.*, 29, 363-376
71. Ebisch, K. E. (1982), “Skyhook: Another Space Construction Project,” *Am. J. Phys.*, 50, 467-469
72. Eder, D. (1981), “A Low Cost Earth Based Launch System and Its Effect on Space Industrialization,” in Space Manufacturing 4, Proc. of the 5<sup>th</sup> Princeton/AIAA Conference, pp. 221-229
73. Edwards, B. C. (2003), The Space Elevator: NIAC Phase II Final Report, <http://www.spaceelevator.com/docs/521Edwards.pdf>
74. Edwards, B. C. (2000a), The Space Elevator, NASA Inst. for Advanced Concepts, <http://www.niac.usra.edu/studies>
75. Edwards, B. C. (2000b), “Design and Deployment of a Space Elevator,” *Acta Astronautica*, 47, 735
76. Edwards, B. C. and Westling, E. A. (2003), The Space Elevator: A revolutionary Earth to space transportation system, self-published, <http://www.spaceelevator.com/docs/>
77. Einstein, A. (1916), *Ann. Phys.*, 49, 769

78. El-Genk, M., et al. (1990), "Pellet Bed Reactor for Nuclear Propelled Vehicles," in NASA Nuclear Propulsion Workshop, NASA-Lewis Research Center, Cleveland OH
79. Evans, J., Nandi, K. and Islam, A. (1996a), "The Optical-Mechanical Analogy in General Relativity: New Methods for the Paths of Light and of the Planets," *Am. J. Phys.*, 64, 1401-1415
80. Evans, J., Nandi, K. and Islam, A. (1996b), "The Optical-Mechanical Analogy in General Relativity: Exact Newtonian Forms for the Equations of Motion of Particles and Photons," *Gen. Rel. Grav.*, 28, 413-439
81. Everson, G. (1949), The Story of Television – The Life of Philo T. Farnsworth, W. W. Norton & Co., Inc., New York
82. Fair, H. D. (1987), "Hypervelocity Then and Now," *Int'l J. Impact Engr.*, 5, 1-11
83. Fair, H. D., et al. (1989), "Electromagnetic Earth-to-Space Launch," *IEEE Trans. on Magnetics*, 25, 9-16
84. Farbman, G. H., et al. (1990), "The ENABLER (Based on Proven NERVA Technology)," in NASA Nuclear Propulsion Workshop, NASA Lewis Research Center, Cleveland OH
85. Farnsworth, P. T. (1956), "Electric Discharge Device for Producing Interactions between Nuclei," U.S. Patent No. 3,358,402 [initially filed May 5, 1956, revised October 19, 1960, filed January 11, 1962, issued June 28, 1966]
86. Forward, R. L. (2001), Personal Communication, Salt Lake City, UT
87. Forward, R. L. (1998), "Apparent Method for Extraction of Propulsion Energy from the Vacuum," AIAA-98-3140, 34<sup>th</sup> AIAA/ASME/SAE/ASEE Joint Propulsion Conference & Exhibit, Cleveland, OH
88. Forward, R. L. (1996), Mass Modification Experiment Definition Study, PL-TR-96-3004, Phillips Laboratory-Propulsion Directorate, Air Force Materiel Command, Edwards AFB, CA
89. Forward, R. L. (1992a), "Failsafe Multistrand Tether Structures for Space Propulsion," AIAA-92-3214, AIAA/ASME/SAE/ASEE 28<sup>th</sup> Joint Propulsion Conference, Nashville, TN
90. Forward, R. L., et al. (1992b), "The Cable Catapult: putting it there and keeping it there," AIAA-92-3077, AIAA/ASME/SAE/ASEE 28<sup>th</sup> Joint Propulsion Conference, Nashville, TN
91. Forward, R. L. (1990), "The Cable Catapult," AIAA-90-2108, AIAA/ASME/SAE/ASEE 26<sup>th</sup> Joint Propulsion Conference
92. Forward, R. L. (1988), Future Magic: How Today's Science Fiction Will Become Tomorrow's Reality, Avon Books, New York
93. Forward, R. L. (1987), Breakthrough Physics, AFAL SR-87-001, Air Force Astronautics Laboratory, Air Force Space Technology Center-Space Division, Air Force Systems Command, Edwards AFB, CA

94. Forward, R. L. (1984), "Extracting electrical energy from the vacuum by cohesion of charged foliated conductors," *Phys. Rev. B*, 30, 1770-1773
95. Forward, R. L. (1963), "Guidelines to Antigravity," *Am. J. Phys.*, 31, 166-170
96. Forward, R. L. (1962), "Pluto: Last Stop Before the Stars," *Science Digest* (Aug. issue), 70-75
97. Forward, R. L. (1961a), "General Relativity for the Experimentalist," *Proc. Institute of Radio Engineers*, 49, 892-904
98. Forward, R. L. (1961b), "Antigravity," *Proc. Institute of Radio Engineers*, 49, 1442
99. Forward, R. L. and Moravec, H. P. (1981), "High Wire Act," *Omni*, 3, no. 10, 44
100. Friedman, S. T. (2004), Personal Communication, Las Vegas, NV
101. Frisbee, R., et al. (1994), "Evaluation of Gun Launch Concepts," AIAA-94-2925, AIAA/ASME/SAE/ASEE 30<sup>th</sup> Joint Propulsion Conference, Indianapolis, IN
102. Frisina, W. (1995), "Linear Turbine Spacecraft for Large-Scale Space Development," *Acta Astronautica*, 35, 43-46
103. Froning, H. D. (2003), Study to Determine the Effectiveness and Cost of a Laser-Propelled "Lightcraft" Vehicle System, AFRL-PR-ED-TR-2003-0033, Special Report, AFRL, Air Force Materiel Command, Edwards AFB, CA
104. Froning, H. D. (1997), "Roadmap" for QED Fusion Engine Research and Development, Final Report for NASA PO No. H280270, NASA-MSFC, Huntsville, AL
105. Froning, H. D., et al. (2003), "Study to Determine the Effectiveness and Cost of a Laser-Powered 'Lightcraft' Vehicle System – Results to Guide Future Developments," in Proc. of the 2<sup>nd</sup> Int'l Symposium on Beamed Energy Propulsion, AIP Press, Sendai, Japan
106. Froning, H. D., et al. (2001), "Concept for a High Performance MHD Airbreathing – IEC Fusion Rocket," in Proc. of the 18<sup>th</sup> Symposium on Space Nuclear Power and Propulsion, AIP Conference Proc. 552, ed. M. S. El-Genk, AIP Press, New York, pp. 963-968
107. Froning, H. D. and Bussard, R. W. (1998), "Aneutronic Fusion Propulsion for Earth-To-Orbit and Beyond," in Proc. of the 15<sup>th</sup> Symposium on Space Nuclear Power and Propulsion, AIP Conference Proc. 420, Vol. 3, ed. M. S. El-Genk, AIP Press, New York, pp. 1289-1294
108. Froning, H. D. and Bussard, R. W. (1993), "Fusion-Electric Propulsion Technology for Hypersonic Flight," in Proc. of the 44<sup>th</sup> IAF Congress, IAF-93-5.3.473, Graz, Austria
109. Gabriel, D. S., et al. (1970), "Nuclear Rocket Engine Program Status – 1970," AIAA Paper No. 70-711, AIAA 6<sup>th</sup> Propulsion Joint Specialist Conference, San Diego, CA
110. Gilreath, H. E., Fristrom, R. M., and Molder, S. (1988), "The Distributed-Injection Ballistic Launcher," *Johns Hopkins APL Technical Digest*, 9, 299-309



111. Glenn, L. A. (1990), "Design Limitations on Ultra-High Velocity Projectile Launchers," *Int'l J. Impact Engr.*, 10, 185-196
112. Glumb, R. J. and Krier, H. (1984), "Concepts and Status of Laser-Supported Rocket Propulsion," *J. Spacecraft and Rockets*, 21, 70-79
113. Gunn, S. V. (1990), "Design of Second-Generation Nuclear Thermal Rocket Engines," AIAA-90-1954, AIAA/ASME/SAE/ASEE 26<sup>th</sup> Joint Propulsion Conference, Orlando, FL
114. Haisch, B., Rueda, A., and Puthoff, H. E. (1994), "Inertia as a zero-point field Lorentz Force," *Phys. Rev. A*, 49, 678
115. Haloulakos, V. E., et al. (1988), "Nuclear Propulsion: Past, Present, and Future," in Proc. of the 5<sup>th</sup> Symposium on Space Nuclear Power Systems, Albuquerque, NM, pp. 329-332
116. Harstad, K. G. (1972), Review of Laser-Solid Interactions and Its Possibilities for Space Propulsion, NASA Technical Memorandum 33-578, NASA Jet Propulsion Lab, Pasadena, CA
117. Hawke, R. S., et al. (1981), "Electromagnetic Railgun Launchers," AIAA-81-0751, AIAA/JSASS/DGLR 15<sup>th</sup> Int'l Electric Propulsion Conference, Las Vegas, NV
118. Hawking, S. W. and Ellis, G. F. R. (1973), The Large-Scale Structure of Space-Time, Cambridge Univ. Press, Cambridge, pp. 88-91 and 95-96
119. Henderson, B. W. (1990), "Livermore Proposes Light Gas Gun for Launch of Small Payloads," *Aviation Week & Space Tech.*, 133, 78-79
120. Herrmann, F. (1989), "Energy Density and Stress: A New Approach to Teaching Electromagnetism", *Am. J. Phys.*, 57, 707-714
121. Hertzberg, A., Bruckner, A. P., and Bogdanoff, D. W. (1988), "The Ram Accelerator: A New Chemical Method of Accelerating Projectiles to Ultrahigh Velocities," *AIAA J.*, 26, 195-203
122. Higgins, A. J. (1997), "A Comparison of Distributed Injection Hypervelocity Accelerators," AIAA-97-2897, AIAA/ASME/SAE/ASEE 33<sup>rd</sup> Joint Propulsion Conference & Exhibit, Seattle, WA
123. Hill, P. G. and Peterson, C. R. (1970), Mechanics and Thermodynamics of Propulsion, Ch. 15: Nuclear Rockets, Addison-Wesley Publ. Co., Reading, MA, pp. 468-489
124. Horman, F. J., et al. (1991), "Particle Fuels Technology for Nuclear Thermal Propulsion," AIAA-91-3457, AIAA/NASA/OAI Conference on Advanced SEI Technologies, Cleveland, Ohio
125. Howe, S. (1985), "Assessment of the Advantages and Feasibility of a Nuclear Rocket for a Manned Mars Mission," in Proc. of the Manned Mars Mission Workshop, Marshall Space Flight Center, Huntsville, AL [LANL Preprint LA-UR-85-2442]
126. Hsieh, T.-M. (1975), "Thermonuclear Fusion Technology And Its Application In Space Propulsion," in Frontiers in Propulsion Research: Laser, Matter-Antimatter, Excited Helium,

- Energy Exchange Thermonuclear Fusion, ed. D. D. Papailiou, NASA-JPL Technical Memorandum 33-722, NASA-CR-142707, California Inst. of Technology, Pasadena, CA, pp. 134-178
127. Huba, J. D. (1994), NRL Plasma Formulary, NRL/PU/6790-94-265, Naval Research Laboratory, Washington DC, p. 44
  128. Hyde, R. A. (1985), "EARTHBREAK: Earth to Space Transportation," *Defense Science* 2003+, 4, 78-92
  129. Hoyt, R. P. (2000a), "Tether Systems for Satellite Deployment and Disposal," IAF-00-S.6.04, 51st International Astronautical Congress, Rio de Janeiro, Brazil
  130. Hoyt, R. P. (2000b), "Commercial Development of a Tether Transport System," AIAA-2000-3842, AIAA/ASME/SAE/ASEE 36<sup>th</sup> Joint Propulsion Conference
  131. Hrbud, I. (2002), "Nuclear and future flight propulsion," *Aerospace America*, no. 12, 66
  132. Hunter, J. W. and Hyde, R. A. (1989), "A Light Gas Gun System for Launching Building Material into Low Earth Orbit," AIAA Paper 89-2439
  133. IEEE (1995): The January 1995 issue of IEEE Trans. on Magnetics is devoted to Railguns
  134. Inatani, Y. (2001), "Flight Demonstration And A Concept For Readiness Of Fully Reusable Rocket Vehicles," in Proc. of the 9<sup>th</sup> Int'l Space Conference of Pacific-Basin Societies (ISCOPS), Pasadena, CA
  135. ISNPS (2003), Short Course – "Space Nuclear Power and Propulsion Systems Technology: Enabling Future Planetary Exploration", Lecture Notebook, Institute for Space and Nuclear Power Studies (ISNPS), University of New Mexico, Albuquerque, NM
  136. Isaacs, J. D., et al. (1966), "Satellite Elongation into a True 'Sky-Hook,'" *Science*, 151, 682-683 (see also *Science*, 152, 800 and *Science*, 158, 947)
  137. Kaloupis, P. and Bruckner, A. P. (1988), "The Ram Accelerator: A Chemically Driven Mass Launcher," AIAA-88-2968, AIAA/ASME/SAE/ASEE 24<sup>th</sup> Joint Propulsion Conference, Boston, MA
  138. Kantrowitz, A. (1972), "Propulsion to Orbit by Ground-Based Lasers," *Astronautics and Aeronautics*, 10, 74-76
  139. Kare, J. T. (1992a), Laser-Powered Heat Exchanger Rocket for Ground-to-Orbit Launch, UCRL-JC-110910 (LLNL 1992)
  140. Kare, J. T. (1992b), "Development of Laser-Driven Heat Exchanger Rocket for Ground-to-Orbit Launch," IAF-92-0614, World Space Congress (Also UCRL-JC-111507, LLNL 1992)
  141. Kare, J. T. (1990a), "Ground To Orbit Laser Propulsion Q Advanced Applications," in Vision-21: Space Travel for the Next Millennium, ed. G. Landis, NASA Conference Publication 10059 (Also UCRL JC104215, LLNL, 1990)

142. Kare, J. T. (1990b), "Laser Supported Detonation Waves and Pulsed Laser Propulsion," in Current Topics in Shock Waves, 17<sup>th</sup> Int'l Symposium on Shock Waves and Shock Tubes, ed. Y. W. Kim, AIP Conference Proceedings 208, Lehigh Univ., Bethlehem, PA, AIP Press (Also UCRL 101677, LLNL, 1989)
143. Kare, J. T. (1990c), "Pulsed Laser Propulsion for Low Cost, High Volume Launch to Orbit," IAF Conference on Space Power, Cleveland, OH (see also Space Power J., 9, no. 1, 1990; UCRL-101139)
144. Kare, J. T. ed. (1987), Proc. of the SDIO/DARPA Workshop on Laser Propulsion, CONF-860778, Vol. 1 – 3, Lawrence Livermore National Laboratory, CA
145. Kineke, J. H. (1960), "An experimental study of crater formation in metallic targets," in Proc. of the 4<sup>th</sup> Hypervelocity Impact Symposium, Eglin AFB, Florida
146. Knowlen, C. and Bruckner, A. P. (2001), "Direct Space Launch Using Ram Accelerator Technology," in Proc. of the 18<sup>th</sup> Symposium on Space Nuclear Power and Propulsion, AIP Conference Proc. 552, ed. M. S. El-Genk, AIP Press, New York, pp. 583-588
147. Kolm, H. H. and Thornton, R. D. (1972), "The Magneplane: Guided Electromagnetic Flight," in Proc. of the 1972 Applied Superconductivity Conference, Annapolis, IN
148. Krall, N. A. (1992), "The POLYWELL<sup>tm</sup>: A Spherically-Convergent Ion Focus Concept," Fusion Technology, 22, 40-42
149. Krasnikov, S. V. (1998), "Hyperfast Interstellar Travel in General Relativity," Phys. Rev. D, 57, 4760-4766
150. Kryukov, P. V. (1995), "BALSAD-Ballistic System for Antiasteroid Defense," in Proc. of the 2<sup>nd</sup> Int'l Workshop on Ram Accelerators, Seattle, WA
151. Lamoreaux, S. K. (1997), "Measurement of the Casimir Force Between Conducting Plates," Phys. Rev. Letters, 78, 5-8
152. Landis, G. A. and Cafarelli, C. (1995), "The Tsiolkovski Tower Reexamined," IAF-95-V.4.07, 46<sup>th</sup> Int'l Astronautical Congress, Oslo, Norway
153. Larson, C. W., Mead, F. B., and Kallioma, W. M. (2002), "Energy conversion in laser propulsion III," in Proc. of the 1<sup>st</sup> Int'l Symposium on Beamed Energy Propulsion, Huntsville, AL, AIP Press
154. Latorre, J. I., Pascual, P. and Tarrach, R. (1995), "Speed of light in non-trivial vacua," Nucl. Phys. B, 437, 60-82
155. Lawrence, R. J., et al. (1991), "System Requirements for Low-Earth-Orbit Launch Using Laser Propulsion," in Proc. of the 6<sup>th</sup> Int'l Conference on Emerging Nuclear Energy Systems (Also SAND 91-1687C, Sandia National Laboratory, 1991)
156. Lee, T. D. (1988), Particle Physics and Introduction to Field Theory, Harwood Academic Press, London

157. Levi-Civita, T. (1917), "Realtà fisica di alcuni spazi normali del Bianchi," *Rendiconti della Reale Accademia dei Lincei, Series 5*, 26, pp. 519-533
158. Lieberman, R. J. (1992), Audit Report On The Timber Wind Special Access Program, Report No. 93-033, Project No. 2AD-0009, Office of the Inspector General, Dept. of Defense, Arlington, VA
159. Lipinski, R. J., et al. (1993), "Space Applications for Contactless Coilguns," *IEEE Trans. on Magnetics*, 29, 691-695
160. Lofstrom, K. H. (1985), "The launch loop – a low cost Earth-to-high orbit launch system," *AIAA-85-1368*
161. Lorenzini, E. C., et al. (2000), "Mission Analysis of Spinning Systems for Transfers from Low Orbits to Geostationary," *J. Spacecraft and Rockets*, 37, 165-172
162. Ludewig, H. (1990), "Particle Bed Reactor," in NASA Nuclear Propulsion Workshop, NASA-Lewis Research Center, Cleveland OH
163. Lvov, V. (1967), "Sky-Hook: Old Idea," *Science*, 158, 946-947
164. March, P. (2001), "LANTR VTOL-SSTO Reusable Heavy Cargo Lifter Launch Vehicle," Briefing to the Advanced Deep Space Transport Group-Propulsion and Power Subgroup, and Private Communications, Lockheed-Martin Co., Houston, TX
165. Mashhoon, B., Hehl, F. W., and Theiss, D. S. (1984), "On the Gravitational Effects of Rotating Masses: The Lense-Thirring Papers Translated," *Gen. Rel. and Grav.*, 16, 711-750
166. McLafferty, G. H. (1970), "Gas-Core Nuclear Rocket Engine Technology Status," *AIAA Paper No. 70-708*, AIAA 6<sup>th</sup> Propulsion Joint Specialist Conference, San Diego, CA
167. Mead, F. B. and Larson, C. W. (2001), "Laser Powered, Vertical Flight Experiments at the High Energy Laser System Test Facility," *AIAA-2001-3661*, AIAA/ASME/SAE/ASEE 37<sup>th</sup> Joint Propulsion Conference, Salt Lake City, UT
168. Mead, F. B., Larson, C. W., and Kalliomaa, W. M. (2002), "A Status Report of the X-50LR Program – A Laser Propulsion Program," *AIAA/ASME/SAE/ASEE 38<sup>th</sup> Joint Propulsion Conference*, Indianapolis, IN
169. Mead, F. B., Myrabo, L. N., and Messitt, D. G. (1998), "Flight and Ground Tests of a Laser-Boosted Vehicle," *AIAA-98-3735*, AIAA/ASME/SAE/ASEE 34<sup>th</sup> Joint Propulsion Conference and Exhibit, Cleveland, OH
170. Mead, F. B. and Nachamkin, J. (1996), "System for Converting Electromagnetic Radiation Energy to Electrical Energy," *United States Patent No. 5,590,031*
171. Messitt, D. G., Myrabo, L. N., and Mead, F. B. (2000), "Laser Initiated Blast Wave for Launch Vehicle Propulsion," *AIAA-2000-3848*, AIAA/ASME/SAE/ASEE 36<sup>th</sup> Joint Propulsion Conference, Huntsville, AL

172. Miley, G. H. ed. (1988), Proc., Minicourse on Fusion Applications in Space, American Nuclear Society Topical Meeting on Fusion Technology, Salt Lake City, UT
173. Miley, G. H. (1987), Advanced Fusion Power: A Preliminary Assessment, Committee on Advanced Fusion Power, Air Force Studies Board, Commission on Engineering and Technical Systems, National Research Council, National Academy Press, Washington, DC
174. Miley, G. H., et al. (1995), "Innovative Technology for an Inertial Electrostatic Confinement Fusion Propulsion Unit," in Fusion Energy in Space Propulsion, Progress in Astronautics and Aeronautics, Vol. 167, ed. T. Kammas, AIAA Press, Washington DC, pp. 161-177
175. Miley, G. H., et al. (1994), "An Inertial-Electrostatic Confinement Neutron-Proton Source," in Proc. of the 3<sup>rd</sup> Int'l Conference on Dense Z-Pinches, AIP Conference Proc. 299, eds. M. Haines and A. Knight, AIP Press, New York, pp. 675-689
176. Miley, G. H., et al. (1993), "Inertial Electrostatic Confinement as a Power Source for Electric Propulsion," in Vision-21 Conference Proc., NASA Conf. Publ. 10129, pp. 185-197
177. Miller, T. (1990), "Nuclear Propulsion Project Overview," in NEP/NTP Workshop Feedback Meeting, Houston, TX
178. Millis, M. G. (2003a), NASA Breakthrough Propulsion Physics (BPP) Project Public Information Site, <http://www.grc.nasa.gov/WWW/bpp/> [see also NASA Breakthrough Propulsion Physics Workshop Proceedings, NASA CP-1999-208694, 1999]
179. Millis, M. G. (2003b), "NASA Breakthrough Propulsion Physics Project: Requiem or Revival?," Oral Presentation, AIAA/ASME/SAE/ASEE 39<sup>th</sup> Joint Propulsion Conference & Exhibit, Huntsville, AL
180. Millis, M. G. (2003c), "Findings of the NASA Breakthrough Propulsion Physics Project," 14<sup>th</sup> Annual Advanced Space Propulsion Workshop, Huntsville, AL
181. Milonni, P. W. (1994), The Quantum Vacuum: An Introduction to Quantum Electronics, Academic Press, NY
182. Minovitch, M. A. (1972), "Reactorless Nuclear Propulsion – The Laser Rocket," AIAA Paper 72-1095, AIAA/SAE 8<sup>th</sup> Joint Propulsion Specialist Conference, New Orleans, LA
183. Moir, R. W. and Barr, W. L. (1973), "'Venetian Blind' Direct Energy Converter for Fusion Reactors," Nuclear Fusion, **13**, 35
184. Moore, E. T., et al. (1965), "Explosive Gas Guns for Hypervelocity Acceleration," in Proc. of the 4<sup>th</sup> Hypervelocity Techniques Symposium, Arnold Air Force Station, TN
185. Moravec, H. (1977), "A Non-Synchronous Orbital Skyhook," J. Astronautical Sci., **25**, 307-322
186. Morgan, J. A. (1997), "A Brief History of Cannon Launch," AIAA-97-3138, AIAA/ASME/SAE/ASEE 33<sup>rd</sup> Joint Propulsion Conference & Exhibit, Seattle, WA

187. Morris, M. and Thorne, K. (1988), "Wormholes in spacetime and their use for interstellar travel: A tool for teaching general relativity," *Am. J. Phys.*, 56, 395-412
188. Moss, R. A. (1989), "Use of a Superconductor Cable to Levitate an Earth Tethered Platform," *J. Astronautical Sci.*, 37, 465-475
189. Mottinger, T. A. and Marshall, L. S. (2001), "The Bridge to Space Launch System," in Proc. of the 18<sup>th</sup> Symposium on Space Nuclear Power and Propulsion, AIP Conference Proc. 552, ed. M. S. El-Genk, AIP Press, New York, pp. 514-518
190. Myrabo, L. N. (2001), "World Record Flights of Beam-Riding Rocket Lightcraft: Demonstration of 'Disruptive' Propulsion Technology," AIAA-2001-3798, AIAA/ASME/SAE/ASEE 37<sup>th</sup> Joint Propulsion Conference, Salt Lake City, UT
191. Myrabo, L. N. (1986), "The Mercury Lightcraft Concept," in Proc. of the SDIO/DARPA Workshop on Laser Propulsion
192. Myrabo, L. N. (1983), Advanced Beamed-Energy and Field Propulsion Concepts, BDM/W-83-225-TR, BDM Corp., Final Report for CalTech and NASA-JPL, NASA Contract NAS7-100
193. Myrabo, L. N. (1982), "A Concept for Light-Powered Flight," AIAA/SAE/ASME 18<sup>th</sup> Joint Propulsion Conference, Cleveland, OH
194. Myrabo, L. N. and Benford, J. (1994), "Propulsion of Small Launch Vehicles using High Power Millimeter Waves," SPIE Paper 2154-23, in Proc. of the OE/LASE '94 Conference, Los Angeles, CA
195. Myrabo, L. N. and Ing, D. (1985), The Future of Flight, Baen Books-Simon and Schuster, New York
196. Myrabo, L. N., Messitt, D. G., and Mead, F. B. (1998), "Ground and Flight Tests of a Laser Propelled Vehicle," AIAA-98-1001, AIAA 36<sup>th</sup> Aerospace Sciences Meeting & Exhibit, Reno, NV
197. Myrabo, L. N., et. al. (1989), Lightcraft Technology Demonstrator, Final Technical Report, Contract No. 2073803 for Lawrence Livermore National Laboratory and the SDIO Laser Propulsion Program
198. Nadler, J. H., et al. (2000), "Inertial-Electrostatic Confinement (IEC) Reactor for Space Propulsion and Power," AIAA-2000-3608, AIAA/ASME/SAE/ASEE 36<sup>th</sup> Joint Propulsion Conference, Huntsville, AL
199. Nadler, J. H., et al. (1992), "Characterization of an Inertial-Electrostatic Confinement Glow Discharge (IECGD) Neutron Generator," *Fusion Technology*, 21, 1639-1643
200. Nagatomo, M. and Kyotani, Y. (1987), "Feasibility Study on Linear-Motor-Assisted Take-Off (LMATO) of Winged Launch Vehicle," *Acta Astronautica*, 15, 851-857

201. NASA Spacelink website information on the DC-X and DC-XA program:  
<http://spacelink.nasa.gov/NASA.Projects/Aerospace.Technology/Research.Aircraft/DC-X.and.DC-XA.Experimental.Craft/.index.html>
202. Nickisch, L. J. and Mollere, J. (2002), "Connectivity and the Origin of Inertia,"  
[http://www.arxiv.org/PS\\_cache/physics/pdf/0205/0205086.pdf](http://www.arxiv.org/PS_cache/physics/pdf/0205/0205086.pdf)
203. Palmer, M. R. and Lenard, R. X. (1991), "A Revolution in Access to Space through Spinoffs of SDI Technology," *IEEE Trans. on Magnetics*, 27, 11-20
204. Papailiou, D. D. ed. (1975), Frontiers in Propulsion Research: Laser, Matter-Antimatter, Excited Helium, Energy Exchange Thermonuclear Fusion, NASA-JPL Technical Memorandum 33-722, NASA-CR-142707, California Inst. of Technology, Pasadena, CA
205. Pauli, W. (1981), Theory of Relativity, Dover reprint, New York, pp. 171-172
206. Pearson, J. (1975), "The Orbital Tower: A Spacecraft Launcher Using the Earth's Rotational Energy," *Acta Astronautica*, 2, 785-799
207. Piltch, M. (2000), Personal Communication, Las Vegas, NV
208. Pirri, A. N., Monsler, J. J., and Nebolsine, P. E. (1973), "Propulsion by Absorption of Laser Radiation," AIAA Paper 73-624, AIAA 6<sup>th</sup> Fluid and Plasma Dynamics Conference, Palm Springs, CA
209. Pirri, A. N. and Weiss, R. F. (1972), "Laser Propulsion," AIAA Paper 72-719, AIAA 5<sup>th</sup> Fluid and Plasma Dynamics Conference, Boston, MA
210. Powell, J. R., et al. (1986), "Technology of Thermal Hypervelocity Launchers," *IEEE Trans. on Magnetics*, 22, 1675-1680
211. Puthoff, H. E. (2002a), "Polarizable-Vacuum (PV) Approach to General Relativity", *Found. Phys.*, 32, 927-943
212. Puthoff, H. E. (2002b), "Polarizable-Vacuum Approach to General Relativity", in Gravitation and Cosmology: From the Hubble Radius to the Planck Scale, eds. R. L. Amoroso, G. Hunter, M. Kafatos, and J.-P. Vigi er, Kluwer Academic Publ., Dordrecht, the Netherlands, pp. 431-446
213. Puthoff, H. E. (1999), "Polarizable-vacuum (PV) representation of general relativity," <http://arxiv.org/abs/gr-qc/9909037>
214. Puthoff, H. E. (1993a), "On the Feasibility of Converting Vacuum Electromagnetic Energy to Useful Form," Int'l Workshop on the Zeropoint Electromagnetic Field, Cuernavaca, Mexico
215. Puthoff, H. E. (1993b), "Reply to 'Comment on Gravity as a zero-point fluctuation force,'" *Phys. Rev. A*, 47, 3454
216. Puthoff, H. E. (1990), "The Energetic Vacuum: Implications for Energy Research," *Spec. in Sci. & Technology*, 13, 247

217. Puthoff, H. E. (1989a), "Gravity as a zero-point fluctuation force," Phys. Rev. A, 39, 2333
218. Puthoff, H. E. (1989b), "Source of vacuum electromagnetic zero-point energy," Phys. Rev. A, 40, 4857
219. Puthoff, H. E., Little, S. R. and Ivison, M. (2002), "Engineering the Zero-Point Field and Polarizable Vacuum for Interstellar Flight," J. British Interplanetary Soc., 55, 137-144
220. Puthoff, H. E., Maccone, C., and Davis, E. W. (2004), "Levi-Civita Effect in the polarizable vacuum (PV) representation of general relativity," submitted to Class. Quant. Grav.
221. Rashleigh, S. C. and Marshall, R. A. (1978), "Electromagnetic acceleration of macroparticles to high velocities," J. Appl. Phys., 49, 2540-2542
222. Reid, A. F. (1972), Preliminary Investigation of an Electromagnetic Gun, NWL Technical Note No. TN-E-10/72, Naval Weapons Laboratory, Dahlgren, VA
223. Rodenberger, C. A. (1969), Obtaining Hypervelocity Acceleration Using Propellant-Lined Launch Tubes, NASA CR-10193 (see also NASA CR-982, NASA CR-1533, and NASA CR-2143)
224. Rodenberger, C. A., Sawyer, M. L., and Tower, M. M. (1970), On the Feasibility of Obtaining Hypervelocity Acceleration Using Propellant Lined Launch Tubes, NASA CR-108699
225. Rom, F. E. and Putre, H. A. (1972), Laser Propulsion, NASA Technical Memorandum TM X-2510
226. Ronen, Y., et al. (2000a), "Ultra-thin  $^{242m}\text{Am}$  fuel element in nuclear reactors," Nucl. Instr. and Meth., A455, 442-451
227. Ronen, Y., et al. (2000b), "A novel method for energy production using  $^{242m}\text{Am}$  as nuclear fuel," Nucl. Tech., 19, 407
228. Roschke, E. J. (1975), "Laser Propulsion – Concepts and Problems," in Frontiers in Propulsion Research: Laser, Matter-Antimatter, Excited Helium, Energy Exchange Thermonuclear Fusion, ed. D. D. Papailiou, NASA-JPL Technical Memorandum 33-722, NASA-CR-142707, California Inst. of Technology, Pasadena, CA, pp. 5-48
229. Rubbia, C. (2000), "Fission fragments heating for space propulsion," CERN SL-Note 2000-036 EET
230. Rubbia, C. (1999), Report of the working group on Project 242, ASI (the Italian Space Agency)
231. Rucker, R. (1977), Geometry, Relativity and the Fourth Dimension, Dover Publ., New York
232. Rueda, A. and Haisch, B. (1998a), "Inertia as reaction of the vacuum to accelerated motion," Phys. Lett. A, 240, 115-126



233. Rueda, A. and Haisch, B. (1998b), "Contribution to inertial mass by reaction of the vacuum to accelerated motion," *Found. Phys.*, 28, 1057-1108
234. Rueda, A., Haisch, B., and Tung, R. (2001), "Gravity and the Quantum Vacuum Inertia Hypothesis I. Formalized Groundwork for Extension to Gravity," [http://xxx.arxiv.org/PS\\_cache/gr-qc/pdf/0108/0108026.pdf](http://xxx.arxiv.org/PS_cache/gr-qc/pdf/0108/0108026.pdf)
235. Rumsfeld, D. H., et al. (2001), Report of the Commission To Assess United States National Security Space Management and Organization, U.S. Congress and the Dept. of Defense, Washington DC
236. Sakharov, A. (1968), "Vacuum Quantum Fluctuations in Curved Space and the Theory of Gravitation," *Sov. Phys. Doklady*, 12, 1040-1041
237. Satsangi, A., et al. (1994), "Innovative Technology for an Inertial Electrostatic Confinement (IEC) Fusion Propulsion Unit," in Proc. of the 11<sup>th</sup> Symposium on Space Nuclear Power and Propulsion, AIP Conference Proc. 301, Vol. 3, eds. M. S. El-Genk and M. D. Hoover, AIP Press, New York, pp. 1297-1302
238. Sawle, D. R. (1969), "Characteristics of the Voitenko High-Explosive-Driven Gas Compressor," *Acta Astronautica*, 14, 393-397
239. Scaled Composites LLC website: <http://www.scaled.com>
240. Scharnhorst, K. (1990), "On Propagation of Light in the Vacuum Between Plates," *Phys. Lett. B*, 236, 354-359
241. Schill, R. A. and Davis, E. W. (2003), "Pulsed Superconducting Coil Gun for Electric Armature Applications," Proposal submitted to the Defense Experimental Program to Stimulate Competitive Research-FY04, Dept. of Electrical and Computer Engineering, University of Nevada-Las Vegas
242. Schroeder, J. M., Gully, J. G., and Driga, M. D. (1989), "Electromagnetic Launchers for Space Applications," *IEEE Trans. on Magnetics*, 29, 504
243. Schulze, N. R. (1991), Fusion Energy for Space Missions in the 21<sup>st</sup> Century, NASA TM4298
244. Scott, W. B. (1995), "Consortium Studies 'Maglifter' Concept," *Aviation Week and Space Tech.*, 142, 69
245. Seigel, A. E. (1979), "Theory of High-Muzzle-Velocity Guns," in Interior Ballistics of Guns, eds. H. Krier and M. Summerfield, vol. 66, AIAA Progress in Astronautics and Aeronautics, pp. 135-175
246. Seigel, A. E. (1965), "The Theory of High Speed Guns," AGARDograph 91
247. Seigel, A. E. and Slawsky, Z. I. (1956), A hypervelocity gun using a shock-compressed steam-heated propellant, NavOrd Report 4345

248. Shaw, B. D., Mitchell, C. E., and Wilbur, P. J. (1985), "The Annular Flow, Electrothermal Plug Ramjet," *J. Propul. and Power*, 1, 417-425
249. SpaceFuture.com, Space Vehicles Designs website, <http://www.spacefuture.com/vehicles/designs.shtml#KANKOHMARU>
250. Stiefel, L. ed. (1988), Gun Propulsion Technology, AIAA Press, New York
251. Takayama, K. and Sasoh, A. eds. (1998), Ram Accelerators, Springer-Verlag, Heidelberg, Germany
252. Tan, Z., Varghese, P. L., and Wilson, D. E. (1996), "Numerical Simulation of the Blast-Wave Accelerator," *AIAA J.*, 34, 1341-1347
253. Tarzhanov, V. I. (1991), "Massive Body Acceleration on the Detonation Wave Front," *Combustion, Explosion, and Shock Waves*, 27, 130-132
254. Taylor, R. A. (1987), "A Space Debris Simulation Facility for Spacecraft Materials Evaluation," *SAMPE Quarterly*, 18, 28-34
255. Thirring, H. (1921), *Z. Phys.*, 22, 29
256. Thirring, H. (1918), *Z. Phys.*, 19, 33
257. Thornton, R. D. (1975), "Magnetic Levitation and Propulsion 1975," *IEEE Trans. on Magnetics*, 11, no. 4
258. Tidman, D. A. (2001), "The Spiral Slingatron Mass Launcher," in Proc. of the 18<sup>th</sup> Symposium on Space Nuclear Power and Propulsion, AIP Conference Proc. 552, ed. M. S. El-Genk, AIP Press, New York, pp. 571-582
259. Tidman, D. A. (1998), "Slingatron Mass Launchers," *J. Propul. and Power*, 14, 537-544
260. Tidman, D. A. (1996), "Sling Launch of a Mass Using Superconducting Levitation," *IEEE Trans. on Magnetics*, 32, 240-247
261. Tidman, D. A., et al. (1996a), "Sling Launch of Materials into Space," *SSI Update*, 22, 1-5
262. Tidman, D. A., et al. (1996b), "Correction," *SSI Update*, 22, 8
263. Tidman, D. A. and Goldstein, S. A. (1980), "Acceleration of Projectiles to Hypervelocities Using a Series of Imploded Annular Plasma Discharges," *J. Appl. Phys.*, 51, 1975-1983
264. Tidman, D. A. and Massey, D. W. (1993), "Electrothermal Light Gas Gun," *IEEE Trans. on Magnetics*, 29, 621-624
265. Tidman, D. A., Witherspoon, F. D., and Parker, J. V. (1993), "A Gas-Insulated Railgun," *IEEE Trans. on Plasma Sci.*, 21, 784-785

266. Van Den Broeck, C. (1999), "A 'warp drive' with more reasonable total energy requirements," [http://xxx.arxiv.org/PS\\_cache/gr-qc/pdf/9905/9905084.pdf](http://xxx.arxiv.org/PS_cache/gr-qc/pdf/9905/9905084.pdf)
267. Vetter, A. A. (1975), "Characterization of Laser Propagation and Coupled Pointing," in Frontiers in Propulsion Research: Laser, Matter-Antimatter, Excited Helium, Energy Exchange Thermonuclear Fusion, ed. D. D. Papailiou, NASA-JPL Technical Memorandum 33-722, NASA-CR-142707, California Inst. of Technology, Pasadena, CA, pp. 49-99
268. Visser, M. (1995), Lorentzian Wormholes: From Einstein to Hawking, AIP Press, New York
269. Visser, M., Kar, S. and Dadhich, N. (2003), "Traversable Wormholes with Arbitrarily Small Energy Condition Violations," *Phys. Rev. Lett.*, 90, 201102
270. Voitenko, A. E. (1990), "Principal Energy Characteristics of a Linear Jet Engine," *J. Appl. Mech. and Tech. Phys.*, 31, 273-275
271. Voitenko, A. E. (1964), "Generation of High-Speed Jets," *Doklady Akademii Nauk SSSR*, 158, 1278-1280
272. Volkov, A. M., Izmet'ev, A. A. and Skrotskii, G. V. (1971), "The propagation of electromagnetic waves in a Riemannian space," *Sov. Phys. JETP*, 32, 686-689
273. Walker, R. S., et al. (2002), Final Report of the Commission on the Future of the United States Aerospace Industry, Commission on the Future of the United States Aerospace Industry, Arlington, VA, <http://www.aerospacecommission.gov/>
274. Walton, D., List, G., and Myrabo, L. N. (1989), "Economic Analysis of a Beam-Powered, Personalized Global Aerospace Transport System," AIAA-89-2443, AIAA/ASME/SAE/ASEE 25<sup>th</sup> Joint Propulsion Conference
275. Walton, J. T. (1991), "An Overview of Tested and Analyzed NTP Concepts," AIAA-91-3503, AIAA/NASA/OAI Conference on Advanced Space Exploration Initiative Technologies, Cleveland, OH [NASA-TM-105252]
276. Wang, T.-S., et al. (2002), "Advanced Performance Modeling of Experimental Laser Lightcraft," *J. Propul. and Power*, 18, 1129-1138
277. Wang, T.-S., et al. (2001), "Advanced Performance Modeling of Experimental Laser Lightcrafts," AIAA-2001-0648, 39<sup>th</sup> AIAA Aerospace Sciences Meeting and Exhibit, Reno, NV
278. Wang, T.-S., et al. (2000), "Performance Modeling of an Experimental Laser Propelled Lightcraft," AIAA-2000-2347, 31<sup>st</sup> AIAA Plasmadynamics and Lasers Conference, Denver, CO
279. Watrus, J. J., et al. (1998), Evaluation of a Fusion-Driven Earth-to-Orbit Thruster, NASA-MSFC Contract No. NAS 8-98106, Numerex Report 98-02, Huntsville, AL
280. Welch, C. S. and Jack, C. (1995), "A Kinetic Tether System for Launching Payloads," in Proc. of the 46<sup>th</sup> Int'l Astronautical Congress, IAF-95-V.4.06

281. Weldon, W. F. (1987), "Development of Hypervelocity Electromagnetic Launchers," *Int'l J. Impact Engr.*, 5, 671-679
282. Wenzel, A. B. and Gehring, J. W. (1965), "Techniques for Launching 0.01 to 25 gm Discrete Projectiles at Velocities Up to 54,100 ft/sec," in Proc. of the 4<sup>th</sup> Hypervelocity Techniques Symposium, Arnold Air Force Station, TN
283. Wett, J. F., et al. (1989), "NERVA-Derivative Reactor Technology – A National Asset for Diverse Space Power Applications," *Space Power*, 8, 115-124
284. Wilbur, P. J., Mitchell, C. E., and Shaw, B. D. (1983), "The Electrothermal Ramjet," *J. Spacecraft and Rockets*, 20, 603-610
285. Wilson, H. A. (1921), "An electromagnetic theory of gravitation," *Phys. Rev.*, 17, 54-59
286. Wilson, D. E. and Tan, Z. (2001), "The Blast Wave Accelerator – Feasibility Study," in Proc. of the 18<sup>th</sup> Symposium on Space Nuclear Power and Propulsion, AIP Conference Proc. 552, ed. M. S. El-Genk, AIP Press, New York, pp. 589-598
287. Wright, S. (1990), "Foil Reactor – Fission Fragment Assisted Reactor Concept for Space Propulsion," in NASA Nuclear Propulsion Workshop, NASA-Lewis Research Center, Cleveland OH

**AFRL-PR-ED-TR-2002-0024**  
**Primary Distribution of this Report:**

AFRL/PRSP (15 CD)  
Dr. Frank Mead  
10 E. Saturn Blvd  
Edwards AFB CA 93524-7680

AFRL/PRSA (1 CD)  
Dr. Jean-Luc Cambier  
10 E. Saturn Blvd.  
Edwards AFB CA 93524-7680

AFRL/PR (1 CD)  
Dr. Alan Garscadden  
1950 Fifth Street  
Building 18  
Wright-Patterson AFB, OH 45433-7251

AFRL/PR Technical Library (2 CD + 1 HC)  
6 Draco Drive  
Edwards AFB CA 93524-7130

Chemical Propulsion Information Agency (1 CD)  
Attn: Tech Lib (Dottie Becker)  
10630 Little Patuxent Parkway, Suite 202  
Columbia MD 21044-3200

Defense Technical Information Center  
(1 Electronic Submission via STINT)  
Attn: DTIC-ACQS (Pat Mawby)  
8725 John J. Kingman Road, Suite 94  
Ft. Belvoir VA 22060-6218

Dr. Eric Davis (10 CD)  
4849 San Rafael Ave.  
Las Vegas, NV 89120

AFRL/PROI (1 HC + 1 CD)  
Ranney Adams  
2 Draco Drive  
Edwards AFB CA 93524-7808

Dr. Ingrid Wysong (1 CD)  
AFRL/PRSA  
10 E. Saturn Blvd.  
Edwards AFB CA 93524-7680

Dr. Greg Benford (1 CD)  
Physics Department  
University of California  
Irvine, CA 92717

Dr. Jim Benford (1 CD)  
Microwave Sciences, Inc.  
1041 Los Arabis Ln.  
Lafayette, CA 94549

Dr. Gary L. Bennett (1 CD)  
7517 West Devonwood Dr.  
Boise, ID 83703

Dr. Mitat Birkan (1 CD)  
AFOSR/NA  
801 N. Randolph St.  
Arlington, VA 22203

Dr. Jon Campbell (1 CD)  
P.O. Box 295  
Harvest, AL 35749

Mr. Michael Libeau (1 CD)  
NSWCDD  
17320 Dahlgren Rd.  
Attn: Code G23 Libeau  
Dahlgren VA 22448

Dr. Phil Carpenter (1 CD)  
US Dept. of Energy  
Oak Ridge National Laboratory  
P.O. Box 2008, MS: 6269  
Oak Ridge, TN 37831

Dr. Brice N. Cassenti (1 CD)  
Pratt & Whitney Aircraft  
400 Main Street – MS: 163-07  
East Hartford, CT 06108

Dr. Chan K. Choi (1 CD)  
Purdue University  
School of Nuclear Engineering  
West Lafayette, IN 47907

Dr. Terry Kammash (1 CD)  
University of Michigan  
Nuclear Engineering Dept.  
Ann Arbor, MI 48109

Dr. Dana Andrews (1 CD)  
P.O. Box 36  
Leavenworth, WA 98826

Dr. Jordon Kare (1 CD)  
222 Canyon Lakes Pl.  
San Ramon, CA 94583

Dr. Robert Frisbee (1 CD)  
JPL, MS 125-109  
4800 Oak Grove Dr.  
Pasadena, CA 91109

Ron J. Kita (1 CD)  
87 Shady Springs DR.  
Doyelstown, PA 18901

Dave Froning (1 CD)  
Flight Unlimited  
5450 Country Club  
Flagstaff, AZ 86004

Dr. Gerald L. Kulcinski (1 CD)  
Nuclear Engineering Dept.  
University of Wisconsin  
1500 Johnson Dr.  
Madison, WI 53706

Geroge D. Hathaway (1 CD)  
Hathaway Consulting Services  
39 Kendal Ave.  
Toronto, Canada, Ontario  
Canada M5R 1L5

Dr. Geoffrey A. Landis (1 CD)  
Sverdrup Technology  
21000 Brookpark Rd., MS 302-1  
Cleveland, OH 44135

Clark W. Hawk, Director (1 CD)  
Propulsion Research Center  
University of Alabama in Huntsville  
5000 Technology Drive, TH S-266  
Huntsville, AL 35899

Dr. Michael LaPointe (1 CD)  
NASA Lewis Research Center, MS: SPTD-1  
21000 Brookpark Rd.  
Cleveland, OH 44135

Alan C. Holt (1 CD)  
NASA/Johnson Space Center  
Code OD  
Houston, TX 77058

Dr. Sheldon Meth (1 CD)  
DARPA  
Tactical Technology Office  
3701 N. Fairfax Dr.  
Arlington, VA 22203

Dr. Steven Howe (1 CD)  
19 Karen Lane  
Los Alamos, NM 87544

Dr. Michael M. Micci (1 CD)  
Prof. of Aerospace Engineering  
233 E. Hammond Bldg.  
University Park, PA 16802

Mike Kaiserman (1 CD)  
Raytheon Missile Systems Company  
Bldg 805, M/S C3  
Tucson, AZ 85734

Dr. Hal Puthoff (1 CD)  
Institute for Advanced Studies  
4030 Braker Lane, West  
Suite 300  
Austin, TX 78759

Dr. George Miley (1 CD)  
University of Illinois, Dept. of Nuclear Engr.  
214 Nuclear Engineering Laboratory  
103 South Goodwin Ave.  
Urbana, IL 61801

Dr. Eric E. Rice (1 CD)  
Orbital Technologies Corp.  
402 Gammon Place, Suite 10  
Madison, WI 53719

Marc Millis (1 CD)  
NASA Glenn Research Center  
M.S. SPTD-2  
21000 Brookpark Road, MS: 86-2  
Cleveland, OH 44135

Dr. Jim Degnan (1 CD)  
AFRL/DEHP  
Kirtland AFB, NM 87117

Dr. Aurthur Morrish (1 CD)  
DARPA/ATO  
3701 N. Fairfax Dr.  
Arlington, VA 22203

Dr. George Schmidt (1 CD)  
NASA HQ  
300 E. Street SW  
Washington, DC 20546

Dr. Paul Murad (1 CD)  
Sr. Analyst, Director for Intel Production  
Missile & Space Intel Center  
Defense Intelligence Agency  
Washington, DC 20340-6054

Steve Squires (1 CD)  
Directorate of Applied Technology  
Test and Simulation  
STEWS-DATTS-OO  
WSMR, NM 88002

Dr. Brian Palaszewski (1 CD)  
NASA Glenn Research Center  
21000 Brookpark Road, MS: 5-10  
Cleveland, OH 44135

Robert Talley (1 CD)  
Topaz 2000, Inc  
3380 Sheridan Dr.  
Suite 172  
Amherst, NY 14226

Dr. Alan Pike (1 CD)  
DSAS  
1988 Crescent Park Drive  
Reston, VA 20190

Dr. Kenneth D. Ware (1 CD)  
Defense Nuclear Agency  
Simulation Technology  
6801 Telegraph Road  
Alexandria, VA 22310

Dr. Dennis Pelaccio (1 CD)  
SAIC  
8100 Shaffer Parkway, Suite 100  
Littleton, CO 80127

Dr. Feiedwardt Winterberg (1 CD)  
University of Nevada  
Desert Research Institute  
Reno, NV 89507

Ben Plenge (1 CD)  
101 W. Eglin Blvd  
Suite 342  
Eglin AFB, FL 32542-6810

Dr. Young Bae (1 CD)  
1101 Bryan Ave.  
Suite C  
Tustin, CA 92780

Dr. James Powell (1 CD)  
Plus Ultra Technologies, Inc.  
25 East Loop Rd.  
Stony Brook, NY 11970-3350

Dr. Thomas M York (1 CD)  
1215 Inverary Pl.  
State College, PA 16801

Mr. Charles A. Yost (1 CD)  
Electric Spacecraft Journal  
73 Sunlight Drive  
Leicester, NC 28748

Dr. Robert J. Barker (1CD)  
AFOSR/NE  
801 N. Randolph St.  
Arlington, VA 22203